



LA1135, 1135M

## AM Tuner System for Car Radios and Home Stereos

### Overview

The LA1135 is a high-performance AM electronic tuner IC that is greatly improved in cross modulation characteristics. It is especially suited for use in car radio and home stereo (antenna: loop) applications.

### Functions

- MIX
- OSC (with ALC)
- IF amplifier
- Detector
- AGC (normal)
- RF wide-band AGC
- Auto search stop signal (signal meter output)
- Local oscillation buffer output
- Others

### Features

- Excellent cross modulation characteristics: Meets the requirements for preventing not only adjacent-channel interference but also interference caused by all channels within broadcast band.
- Narrow-band signal meter output: Usable as auto search stop signal. Has linearity up to 80 dB $\mu$ .
- Local oscillation buffer output: Facilitates designing of electronic tuner system, frequency display, etc.
- OSC (with ALC): Improves tracking error because oscillation output is stabilized at a low level (380 mVrms) for varactor diode.
- MIX: Double-balanced differential MIX meeting the requirements for preventing spurious interference, IF interference.
- Good characteristics at high input: 130 dB $\mu$  input  
 $f_m = 400$  Hz 80% mod THD = 0.4% typ
- Low noise: Good S/N at medium input (56 dB typ)
- Usable sensitivity: (S/N = 20 dB input): 25 dB $\mu$  (2SK315  
 $I_{DSS} = 11$ mA)
- $V_{CC}$  variation compensation: Less variation in gain, distortion: 8 to 12 V
- Reduced pop noise: Capable of reducing pop noise at the time of  $V_{CC}$  ON, mode select by adjusting AGC time constant.

### Package Dimensions

unit : mm

#### 3021B-DIP20S

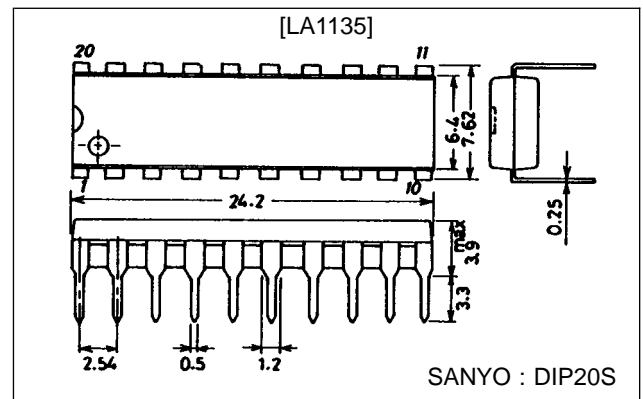

unit : mm

#### 3036B-MFP20

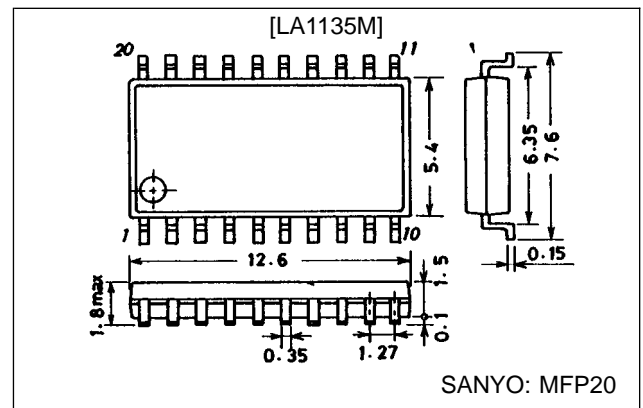

# LA1135, 1135M

## Specifications

### Maximum Ratings at $T_a = 25^\circ\text{C}$

Parameter	Symbol	Conditions	Ratings	Unit
Maximum supply voltage	$V_{CC}$ max	Pins 8, 14	16	V
Output voltage	$V_O$	Pins 7, 10	24	V
Input voltage	$V_{IN}$	Pin 6	5.6	V
Current drain	$I_{CC}$	Pins 7 + 8 + 10 + 14	41	mA
Flow-out current	$I_{18}$	Pin 18	2	mA
	$I_{20}$	Pin 20	2	mA
Allowable power dissipation	$P_d$ max	LA1135	730	mW
		LA1135M $T_a \leq 60^\circ\text{C}$ , with PCB	660	mW
Operating temperature	$T_{opr}$	LA1135	-20 to +70	$^\circ\text{C}$
		LA1135M	-40 to +80	$^\circ\text{C}$
Storage temperature	$T_{stg}$		-40 to +125	$^\circ\text{C}$

### Operating Conditions at $T_a = 25^\circ\text{C}$

Parameter	Symbol	Conditions	Ratings	Unit
Recommended supply voltage	$V_{CC}$		8	V
Operating supply voltage range	$V_{CC}$ op		7.5 to 12	V

### Operating Characteristics at $T_a = 25^\circ\text{C}$ , $V_{CC} = 8\text{ V}$ , $f_r = 1\text{ MHz}$ , $f_m = 400\text{ Hz}$ , See specified Test Circuit.

Parameter	Symbol	Conditions	min	typ	max	Unit
Current drain	$I_{CC1}$	Quiescent	13.5	22.5	32.5	mA
	$I_{CC2}$	130 dB $\mu$ input	20.0	30.0	41.0	mA
Detection output	$V_{O1}$	16 dB $\mu$ input, 30% mod	-29.0	-25.0	-21.0	dBm
	$V_{O2}$	74 dB $\mu$ input, 30% mod	-15.0	-12.0	-9.0	dBm
Signal-to-noise ratio	S/N	74 dB $\mu$ input, 30% mod	51.0	56.0		dB
Total harmonic distortion	THD1	74 dB $\mu$ input, 30% mod		0.3	1.0	%
	THD2	74 dB $\mu$ input, 80% mod		0.3	1.0	%
	THD3	130 dB $\mu$ input, 80% mod		0.4	2.0	%
Signal meter output	$V_{SM1}$	Quiescent		0	0.3	V
	$V_{SM2}$	130 dB $\mu$ input	3.5	5.0	7.5	V
Input at signal meter output 1 V	$V_{IN1}$	$V_{SM} = 1\text{ V}$	18.0	24.0	30.0	dB $\mu$
Local oscillation buffer output	$V_{OSC}$ BUF		320	380		mVrms

# LA1135, 1135M

## Reference Characteristics

Parameter	Symbol	Conditions	typ	Unit
Usable sensitivity	Q.S.	Input at S/N = 20 dB (2SK315 I <sub>DD5</sub> = 11 mA)	25.0	dBμ
Wide-band AGC ON-state input		Reception 1.0 MHz quiescent Interference 1.4 MHz non-mod at input for AMT.D. ON	82.0	dBμ
Detection output variation	$\Delta V_O$	Input 74 dBμ → 130 dBμ	0.2	dB
Local oscillation variation within broadcast band	$\Delta V_{OSC}$	$V_{OSC L} - V_{OSC H}$	15	mVrms
Signal meter band *	$V_{SM-BW1}$	74 dBμ input, frequency at which output is reduced to 1/2	±1.5	kHz
	$V_{SM-BW2}$	74 dBμ input, frequency at which output is reduced to 1/10	-4.5/+7	kHz
Selectivity		30 % mod ±10 kHz *	43	dB
IF interference	IF. R.	$f_r = 600$ kHz *	77.5	dB
Image frequency interference	IM. R.	$f_r = 1400$ kHz *	52.0 (63.0)	dB

Note: \*: Wide-band AGC OFF  
( ): See circuit on page 7.

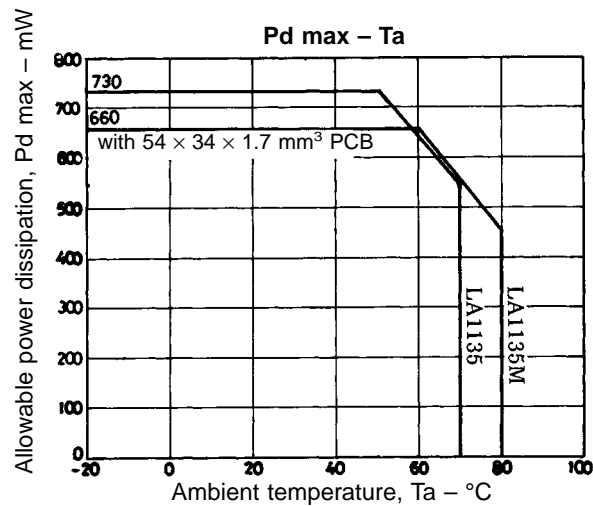

## Equivalent Circuit Block Diagram

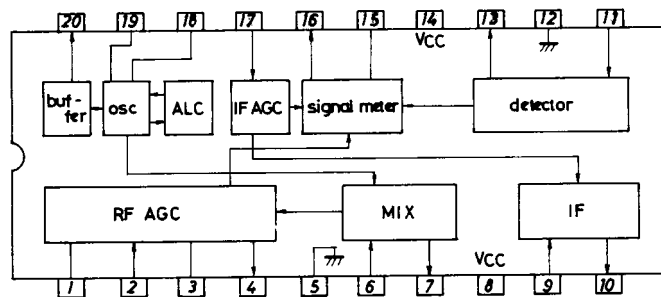

# LA1135, 1135M

## Test Circuit 1

$V_{CC} = 8\text{ V}$ ,  $f_r = 1\text{ MHz}$ ,  $f_m = 400\text{ Hz}$

Unit (resistance:  $\Omega$ , capacitance: F)

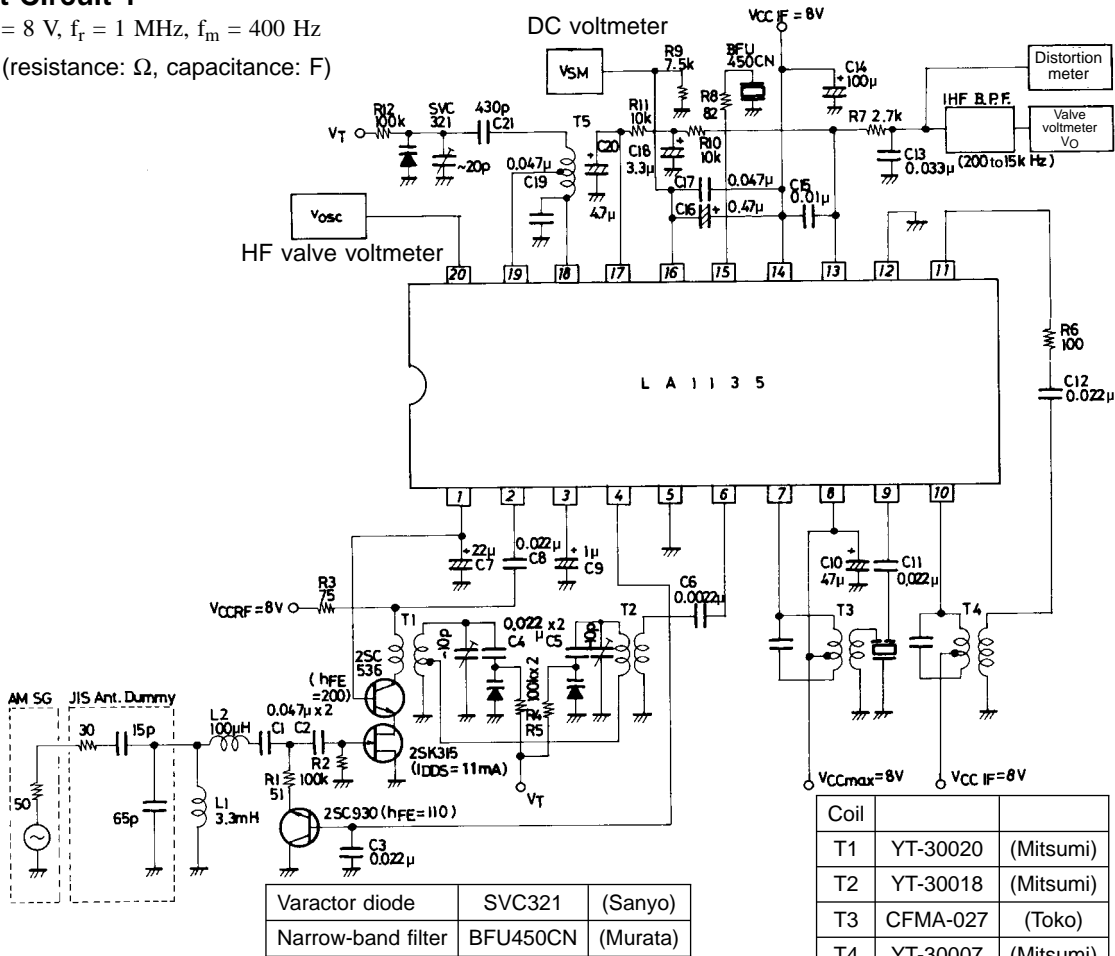

Coil		
T1	YT-30020	(Mitsumi)
T2	YT-30018	(Mitsumi)
T3	CFMA-027	(Toko)
T4	YT-30007	(Mitsumi)
T5	YT-30008	(Mitsumi)

## Sample Printed Circuit Pattern

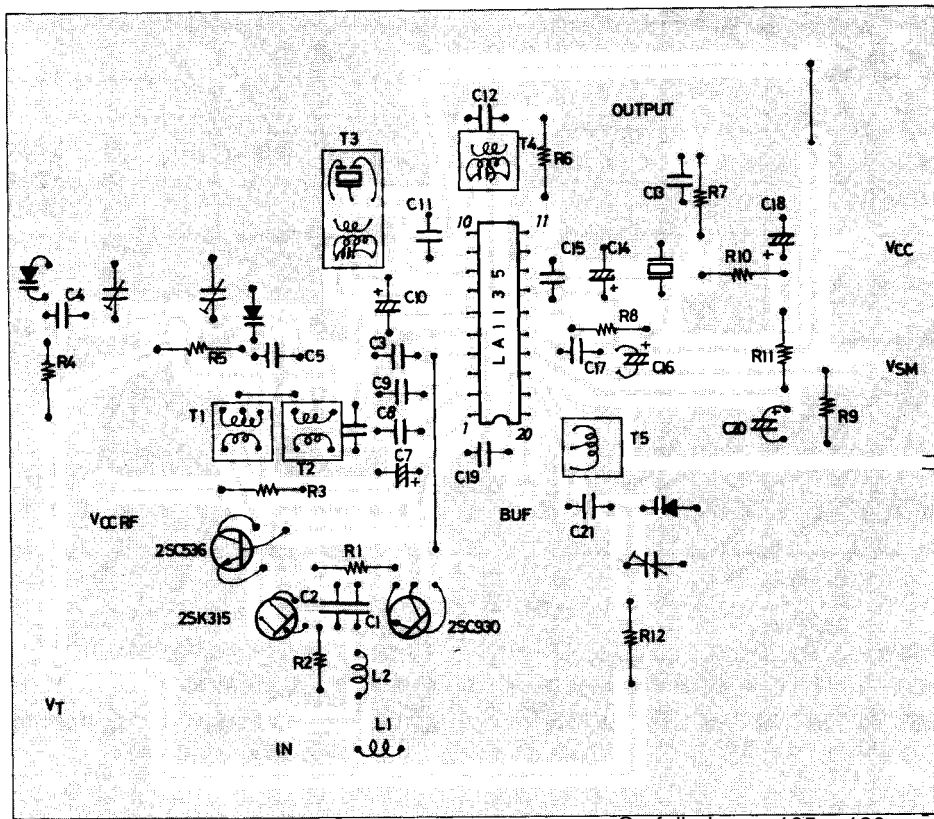

Cu-foiled area 105 x 120 mm

# LA1135, 1135M

## Test Circuit 2

$V_{CC} = 8\text{ V}$ ,  $f_r = 1\text{ MHz}$ ,  $f_m = 400\text{ Hz}$

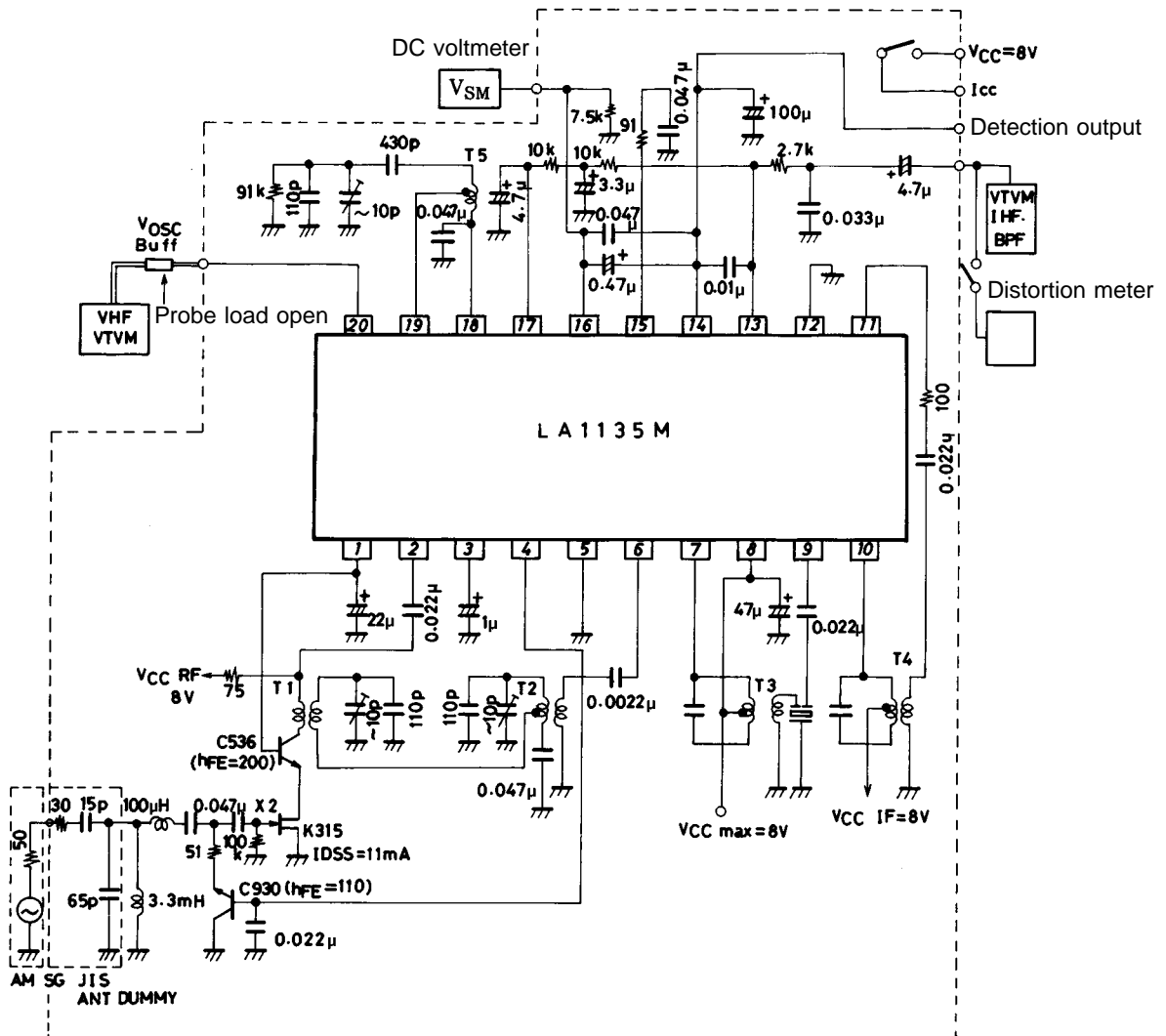

Unit (resistance:  $\Omega$ , capacitance: F)

Coil		
T1	YT-30202	(Mitsumi)
T2	YT-30018	(Mitsumi)
T3	CFMA-021A	(Toko)
T4	YT-30007	(Mitsumi)
T5	YT-30008	(Mitsumi)

Varactor diode	SVC321	(Sanyo)
Narrow-band filter	BFU450CN	(Murata)

**Proper cares in using IC**

1. Bias condition: RF  $V_{CC} \cong$  IF  $V_{CC}$
2. Avoid coupling between the antenna tuning circuit and the local oscillation.
3. Connect detection capacitor C15 across pins 13 (output) and 14 ( $V_{CC}$ ) so that no leakage of the IF signal to the GND line occurs. (If connected to GND, the tweet and the usable sensitivity may get worse.) Radiation from C15 may cause harmonics in the IF signal to return to the RF stage, thereby leading to more tweet interference. So, connect C15 as close to pins 13, 14 as possible. Consider the direction of the capacitor and separate it from the ANT circuit.
4. For R9, use a semifixed resistor with  $V_{SM}$  considered.
5. When designing the coils, consider the following conditions.  
Shown below is the input level at each pin at which the detection output at  $f_m = 400$  Hz 30% mod becomes  $-25$  dB.

ANT	MIX	IF	Det
16.0	28.0	45.0	61.0

(dB $\mu$ )

**How to apply input to each stage**

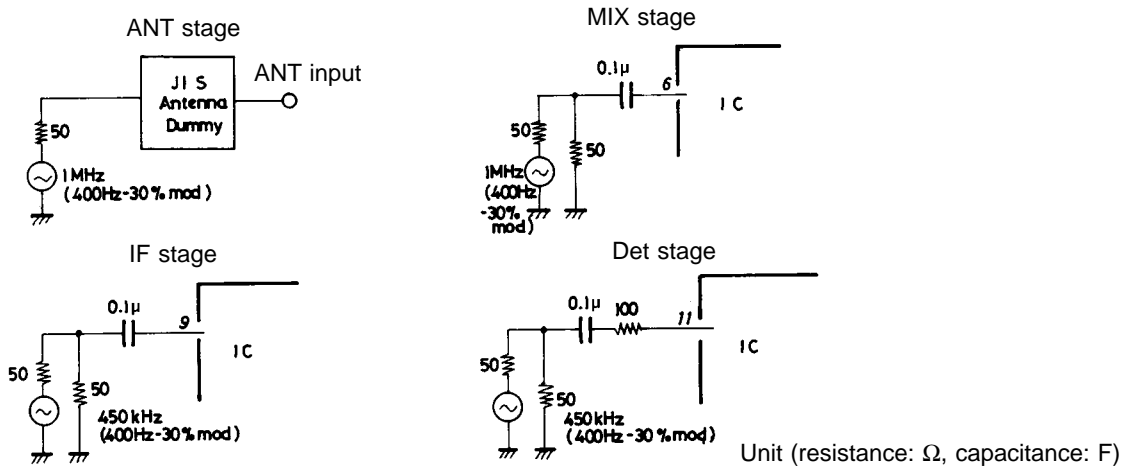

6. ANT damping

To make the ANT damping constant within the receiving band, change the application circuit as shown below.

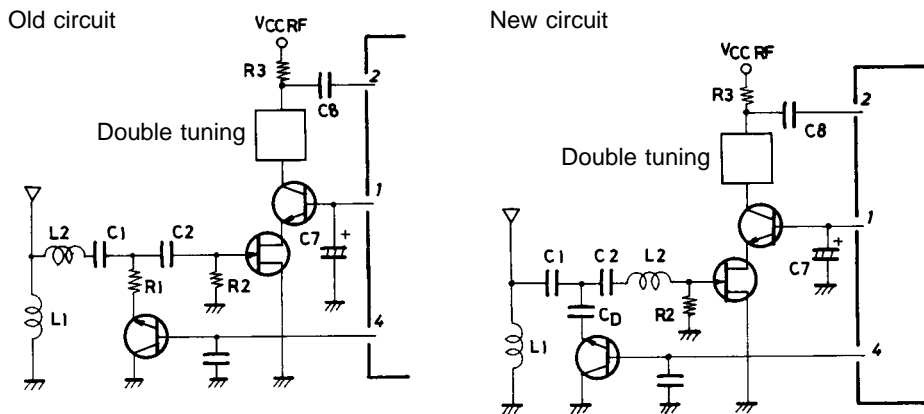

Measures

- Replace R1 with  $C_D$ .
- $C_D$  (2000 pF to 3000 pF or thereabouts)
- Relocate L2.

Damping (600 kHz to 1400 kHz) Old circuit  $-15$  dB  
New circuit  $-4$  dB

## LA1135, 1135M

7. Meaning of L2

If the RF stage is double-tuned, the difference in sensitivity within the RF band almost disappears, but an antiresonance point of approximately 20 MHz appears, thereby leading to worse spurious characteristics. So, L2 is used to remove the SW band.

8. Wide-band AGC

This IC contains 2-channel wide-band AGC. Pin 6 detects an undesired signal within the RF band and wide-band AGC is applied. This detection sensitivity is determined inside the IC. Pin 2 detects an undesired signal outside the RF band. This detection sensitivity is determined by R3. When 1 mVrms (f = 1 MHz) signal is applied to pin 2, AGC operates.

9. Measures against suppression of sensitivity

In the AGC circuit of the test circuit the presence of an undesired signal of high strength within the receiving band may cause the desired signal to be suppressed when the desired signal is low or medium in strength. Shown below is the circuit configuration where the necessary measures are taken against this suppression.

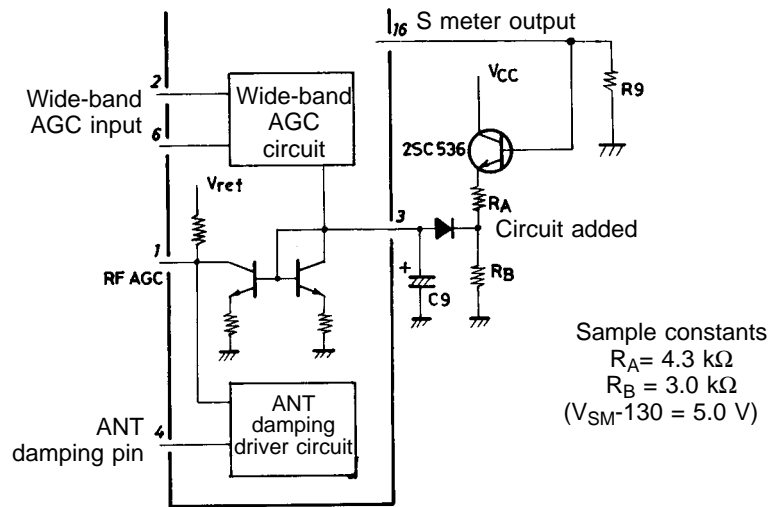

10. Transient response of S meter output at search, stop mode

The circuit configuration shown below is available to stabilize the transient response of the S meter output at the search, stop mode.

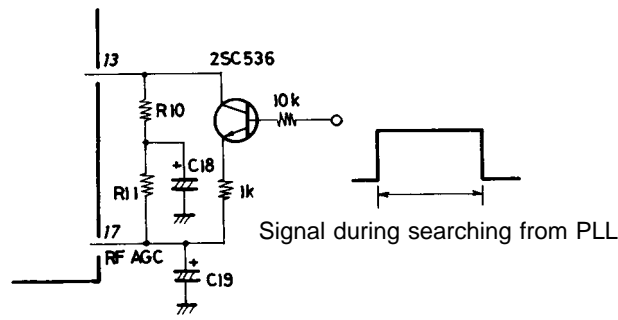

11. When using LW (approximately 50°C or greater), additionally connect a resistor of 27 kΩ across pins 18 and 19 against increase in local oscillation level. When using MW, no additional resistor is required.

12. Improvement in image frequency interference

Change the RF double-tuning coil as follows, and the image frequency interference becomes 63 dB at  $f_i = 1400 \text{ kHz}$ . (Q of the tuning circuit must not be decreased with resistor 100 kΩ.)

# LA1135, 1135M

Continued from preceding page.

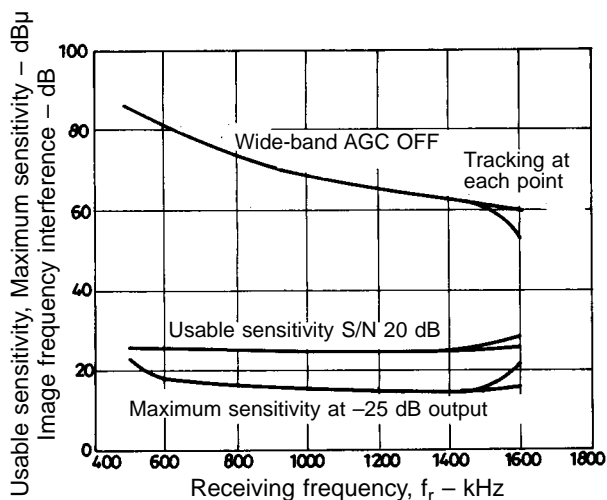
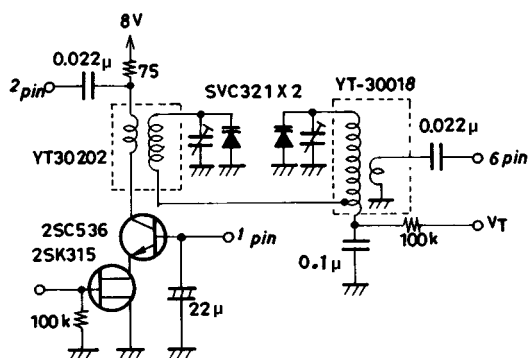

Unit (resistance: Ω, capacitance: F)

Specification for coil

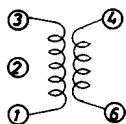

	YT-30202(Mitsumi)	2157-2239-649 (Sumida)
1-3	84T	7BRS-9286A (Toko)
4-6	17T	

- The variations (especially in case of small coupling coefficient) in the oscillation coil may cause a parasitic oscillation of approximately 100 MHz to occur at the local oscillation buffer output (pin 20) at low temperatures. In this case, connect a capacitor of 30 pF or greater across pin 20 and GND. (When the oscillation coil is used with no tap, no problem arises.)
- The recommended double-tuning circuit has a loose coupling at 2T. Therefore, the change in the total number of turns may affect the coupling coefficient subtly, causing a tight coupling and making the selectivity characteristic double-humped. Especially for a receiving band of 1400 kHz or more, the tracking method may affect the band characteristic of sensitivity and the cross modulation characteristic considerably. When making a design, check to see if critical coupling occurs or not.
- Sensitivity difference at 600 kHz or less

In the application circuit configuration shown below, the bypass capacitor in the position where the tuning voltage is applied and coupling L for double-tuning may cause an antiresonance point of 400 kHz to 600 kHz depending on the variations in the coil, varactor diode, etc. The value of the bypass must be 0.047 µF or greater. The recommended value is 0.1 µF.

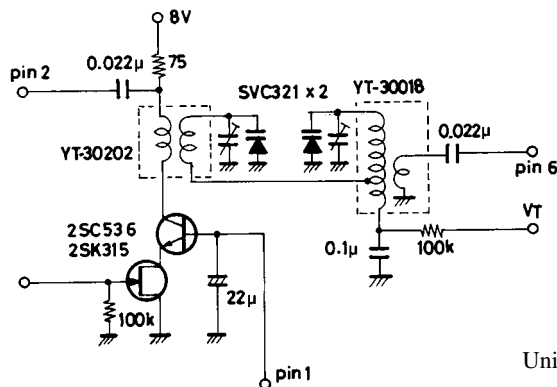

Unit (resistance: Ω, capacitance: F)



16. Measure against suppression of sensitivity in the presence of an undesired signal of high strength  
(Sample application where two PIN diodes are used in the antenna damping circuit)

The LA1135 contains the wide-band AGC circuit (wide-band AGC with pin 2 input) against cross modulation which occurs because an undesired signal of high strength distorts the FET input. The AGC = ON level depends on the value of external resistor R3 as shown below.

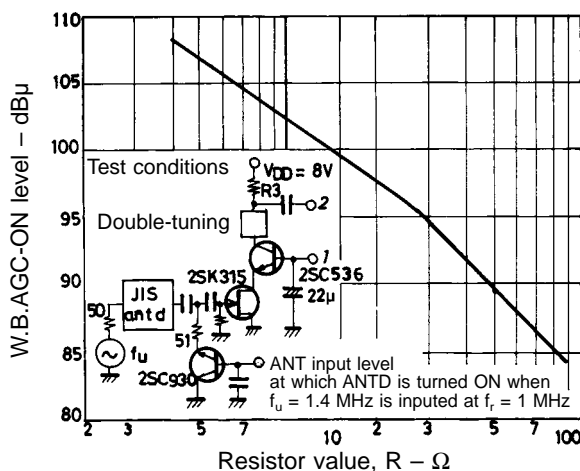

When a nonlinear element, such as transistor, is used for antenna damping, cross modulation which occurs when the transistor is turned ON is as shown below.

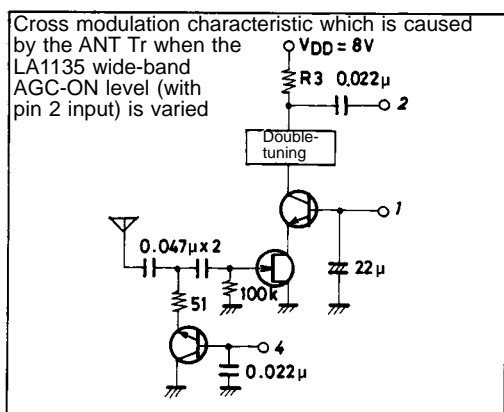

Unit (resistance: Ω, capacitance: F)

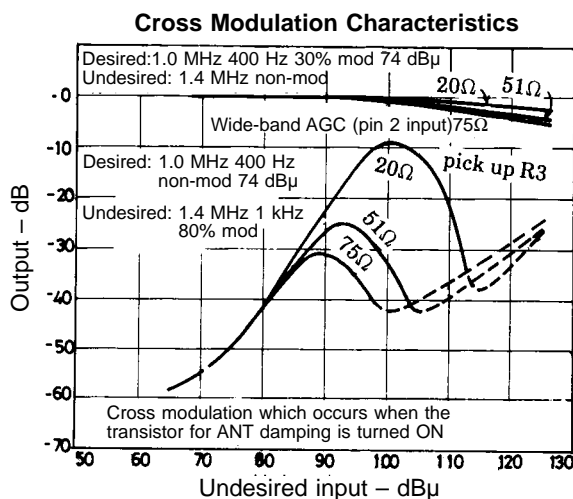

The dynamic range of the FET input covers up to approximately 110 dBμ of antenna input, but the AGC-ON level must be set lower because of the bad effect shown above.

Therefore, there are some cases where it is difficult to receive a desired signal of low strength in the presence of an undesired signal of high strength. To solve this problem, a sample application circuit where two PIN diodes with good linearity are used for antenna damping and its cross modulation characteristic are shown below.

Sample Application Circuit where two PIN diodes are used for ANT damping

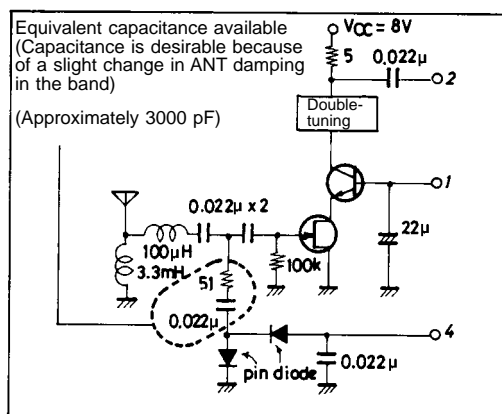

Unit (resistance: Ω, capacitance: F)

# LA1135, 1135M

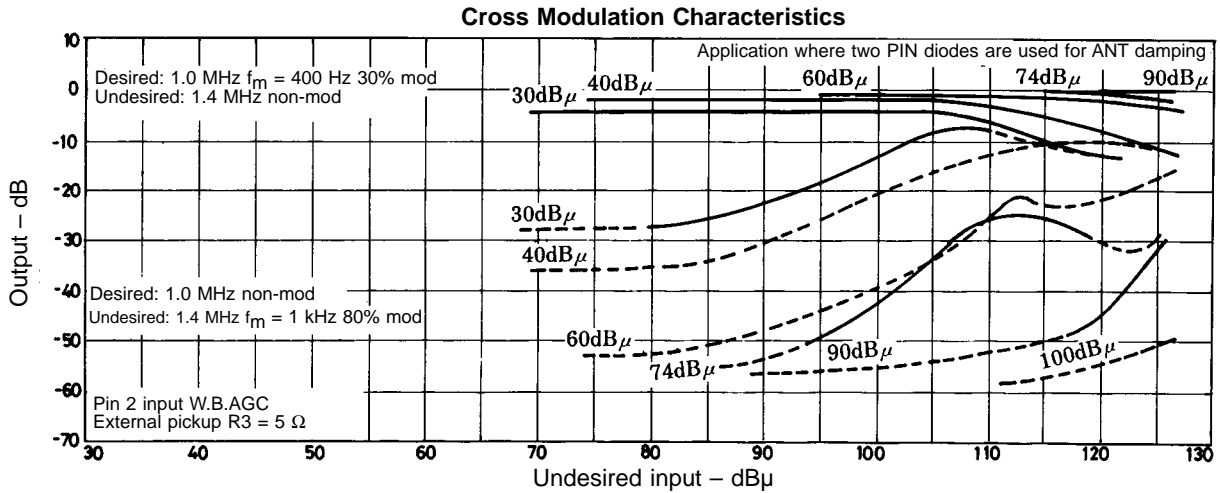

17. For details of the LA1135 wide-band AGC, refer to Technical Data No.79.

## External Parts

(1) RF double-tuning coil

Primary

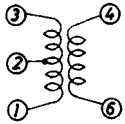

$L_{1-3} = 224 \mu H$

	YT-30020 (Mitsumi)	2157-2239-518A (Sumida)	7BRS-8934A (Toko)
1-2	2T	2T	2T
6-4	37T	40T	35T
2-3	82T	90T	75T

Secondary

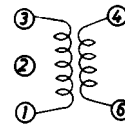

$L_{1-3} = 224 \mu H$

	YT-30018 (Mitsumi)	2157-2239-517A (Sumida)	7BRS-8932A (Toko)
1-2	2T	2T	2T
6-4	15T	16T	14T
2-3	82T	90T	75T

(2) OSC coil

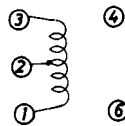

$L_{1-3} = 118 \mu H$

	YT-30008 (Mitsumi)	2157-2239-516 (Sumida)	7BR-5941Y (Toko)
1-2	29T	34T	29T
2-3	29T	35T	29T

(3) IFT (I)

High selectivity type

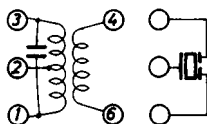

	CFMA-027 (Toko)
1-2	69T
2-3	77T
4-6	14T
Center frequency 450 kHz $Q_u = 115 \pm 20\%$ Tuning capacitance 180 pF	

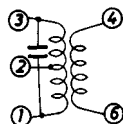

	YT-30042 (Mitsumi) +SFP450H (Murata)
1-2	49T
4-6	27T
2-3	103T
Center frequency 450 kHz $Q_u = 45 \pm 20\%$ Tuning capacitance 180 pF	

# LA1135, 1135M

(4) IFT (II)

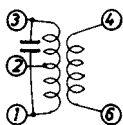

	YT-30007 (Mitsumi)	4140-1289-164 (Sumida)	7MC-6272N (Toko)
1-2	115T	111T	110T
4-6	6T	6T	6T
2-3	37T	36T	36T
	Center frequency 455 kHz, Qu = 110% Tuning capacitance 180 pF	Center frequency 455 kHz, Qu = 110% Tuning capacitance 180 pF	Center frequency 455 kHz, Qu = 110% Tuning capacitance 180 pF

(5) Varactor diode: SVC321

(6) FET at RF stage: 2SK315 F, G  
2SK427 T, U

(7) Transistor for AGC  
FET AGC: 2SC536 F, G  
ANT damping: 2SC930 E

(8) Narrow-band resonator BFU450CN Murata

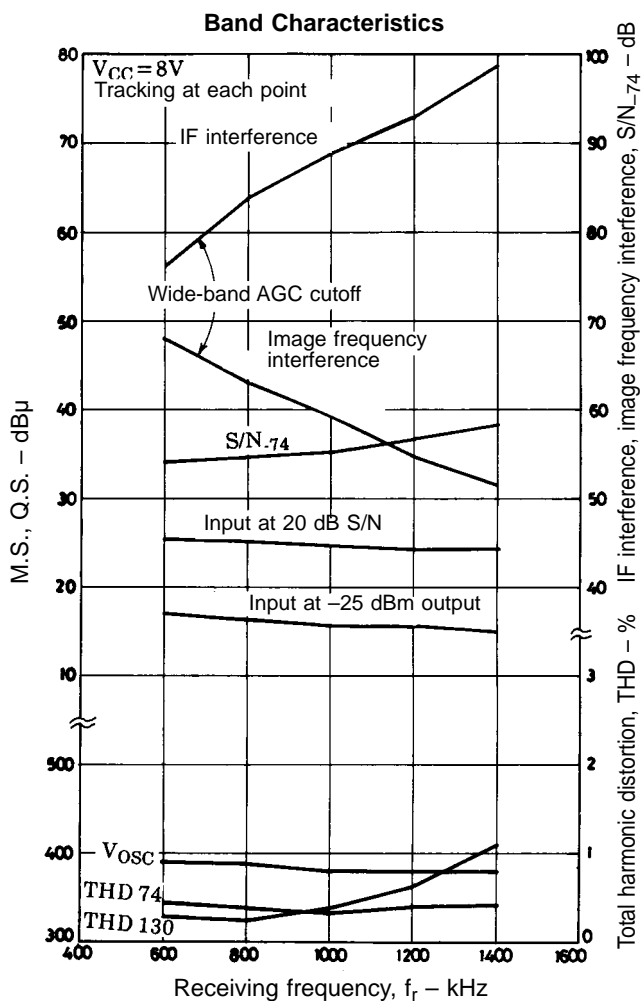
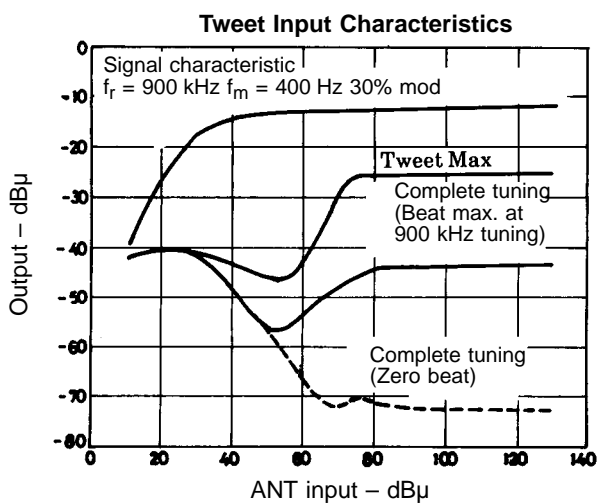
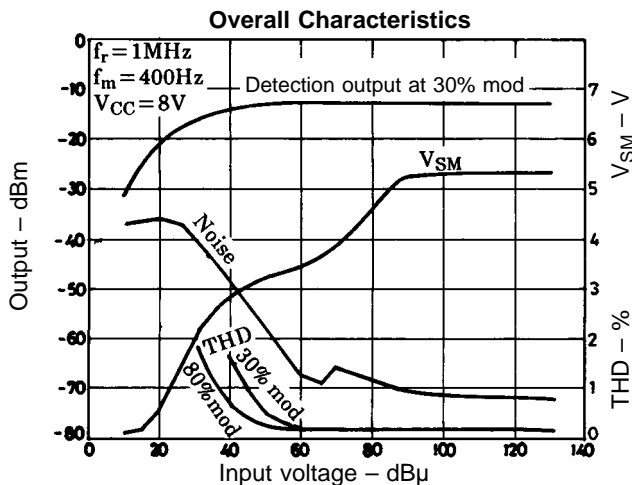

Detuning Characteristics

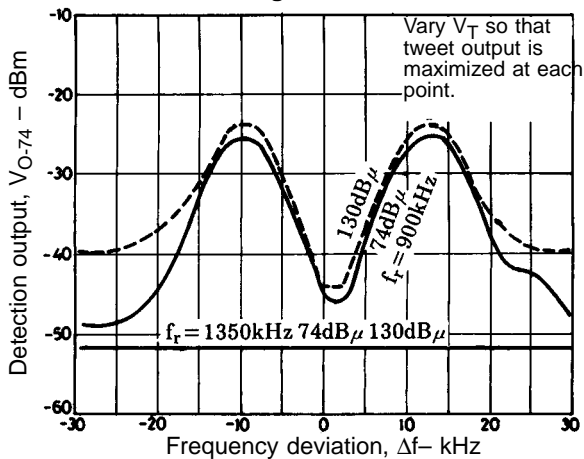

Spurious Characteristics

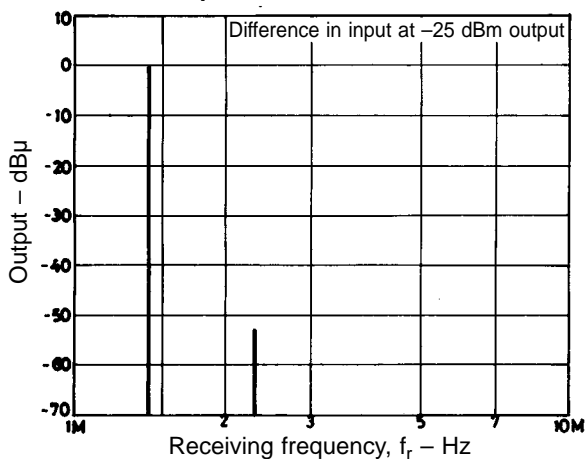

THD - f\_m

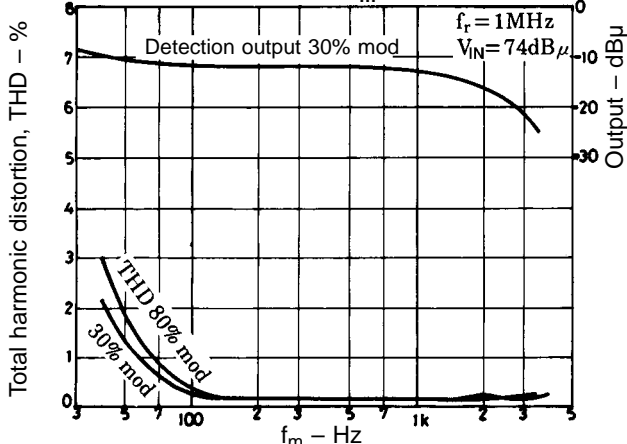

Detection Output, THD - Modulation Characteristics

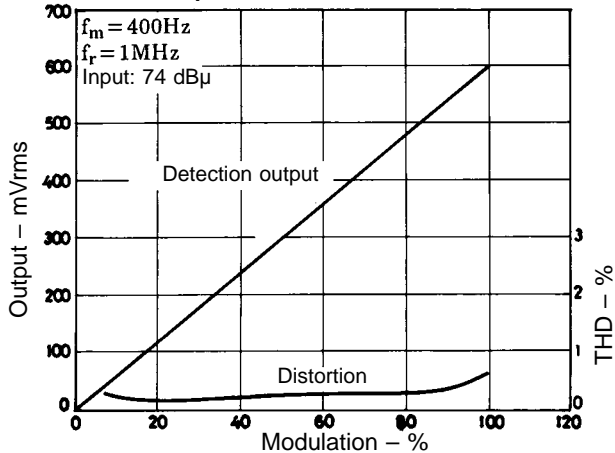

Selectivity Characteristics

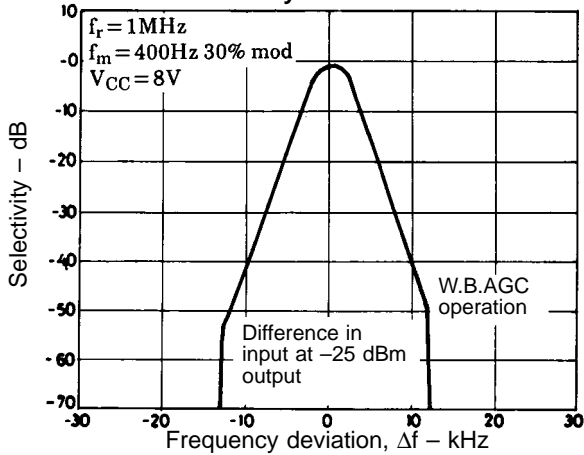

Detuning Characteristics

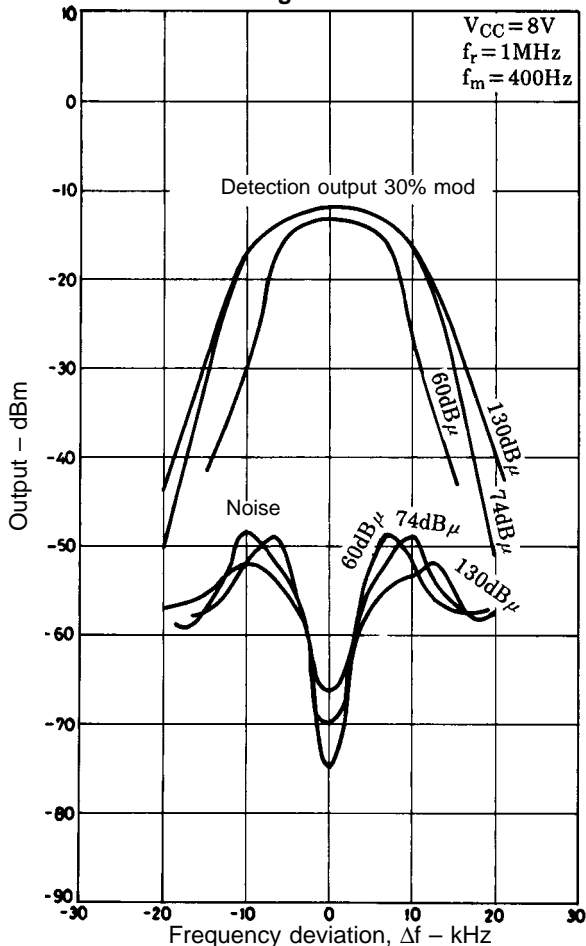

Detuning Characteristics

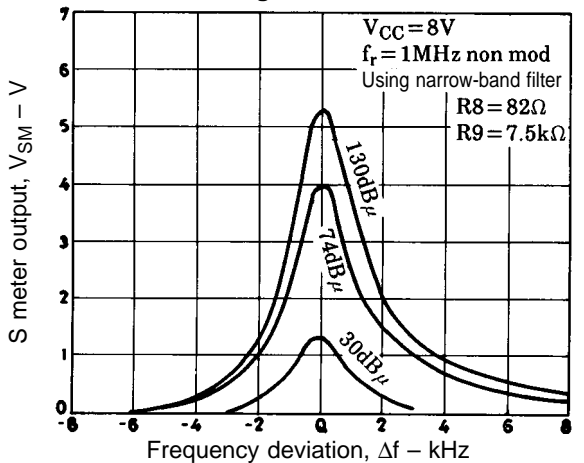

# LA1135, 1135M

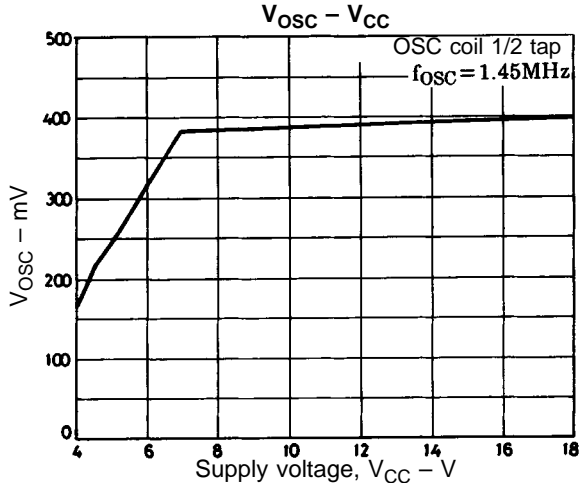
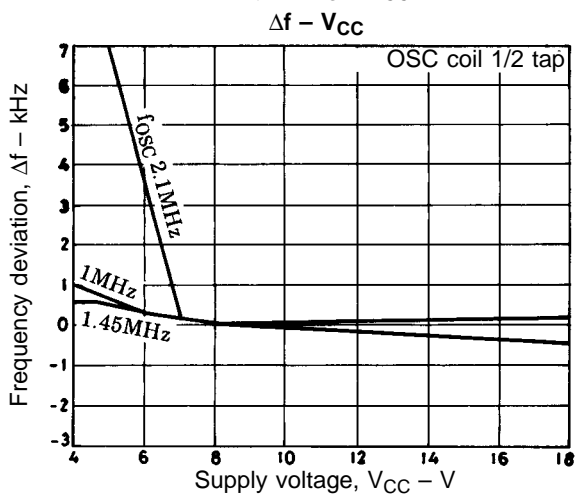
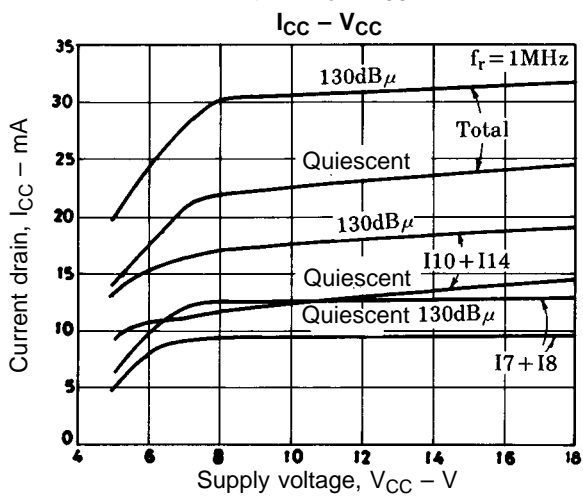
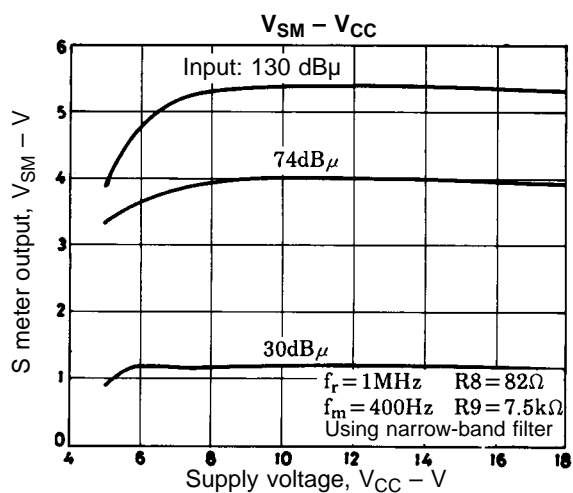
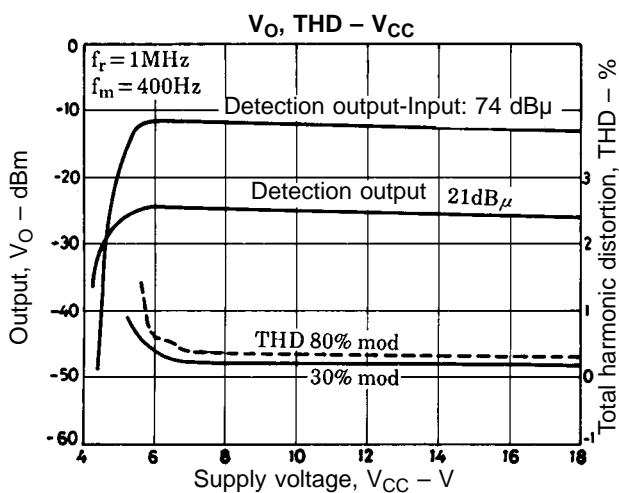

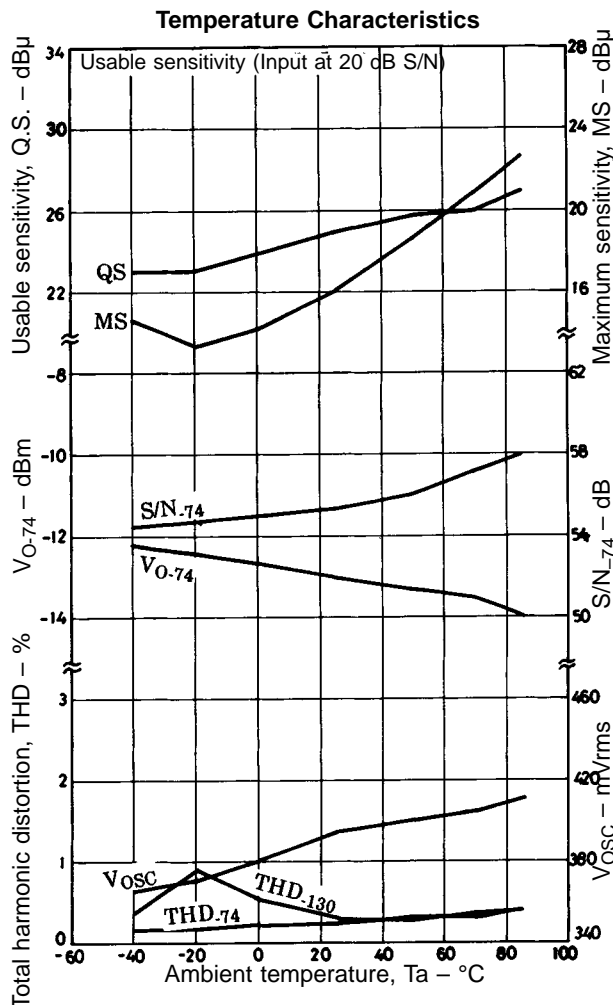
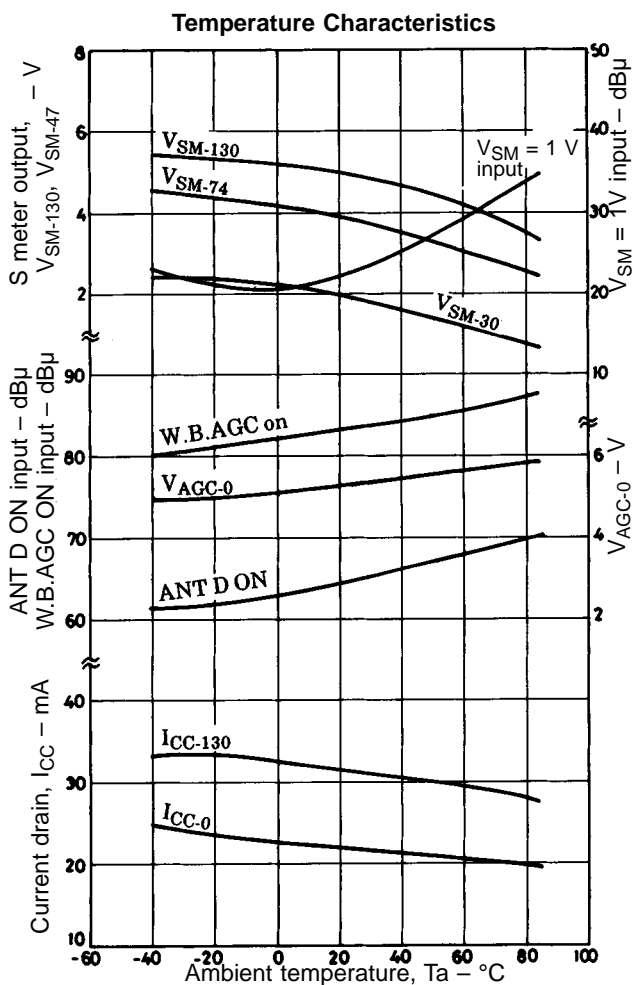

### Cross Modulation Characteristics Testing Method

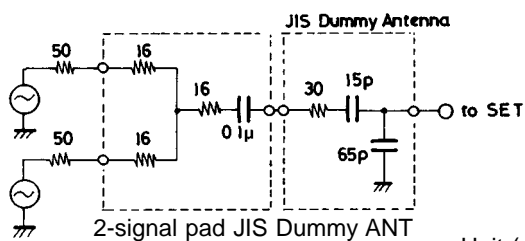

Unit (resistance:Ω, capacitance: F)

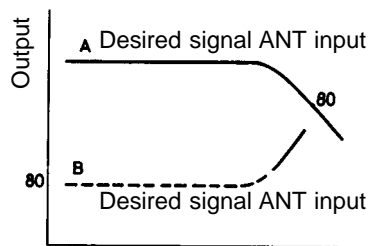

Solid line — Interference  
Dotted line ---- No interference

A: Desired signal 80 dBu 400 Hz 30% mod.  
The strength of an undesired signal (non-mod) causes the desired signal to be suppressed.

B: Desired signal 80 dBu non-mod.  
The strength of an undesired signal (400 Hz 80% mod) causes interference to occur.

Cross Modulation Characteristics

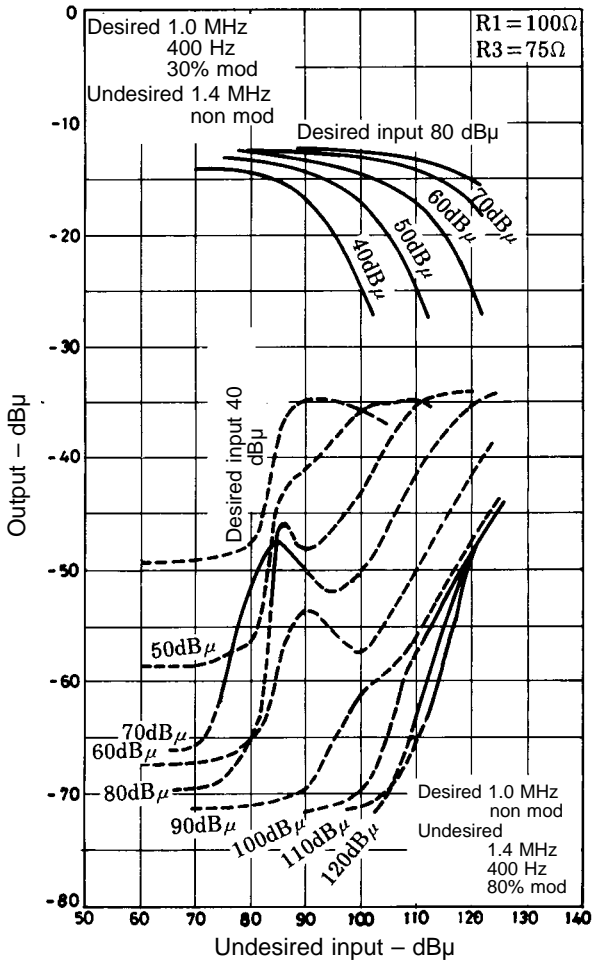

Cross Modulation Characteristics

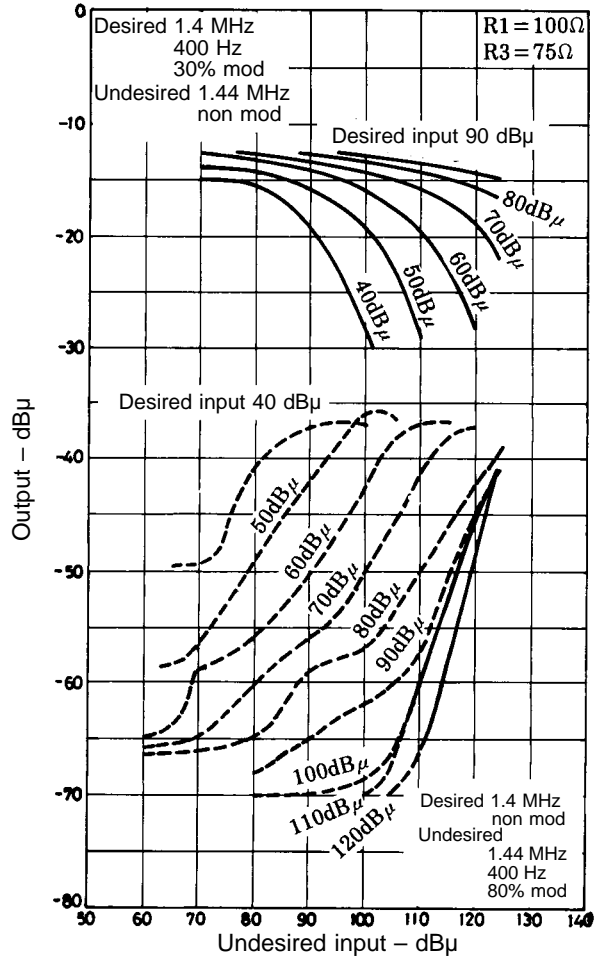

Specification for LA1135 loop ANT

(1) Features of specification for LA1135 loop ANT

1) Excellent high-input characteristic

The antenna damping circuit prevents the antenna circuit from being magnetic-saturated, which results in worsened characteristic, at a high input.

2) Excellent cross modulation characteristic

(2) Application circuit

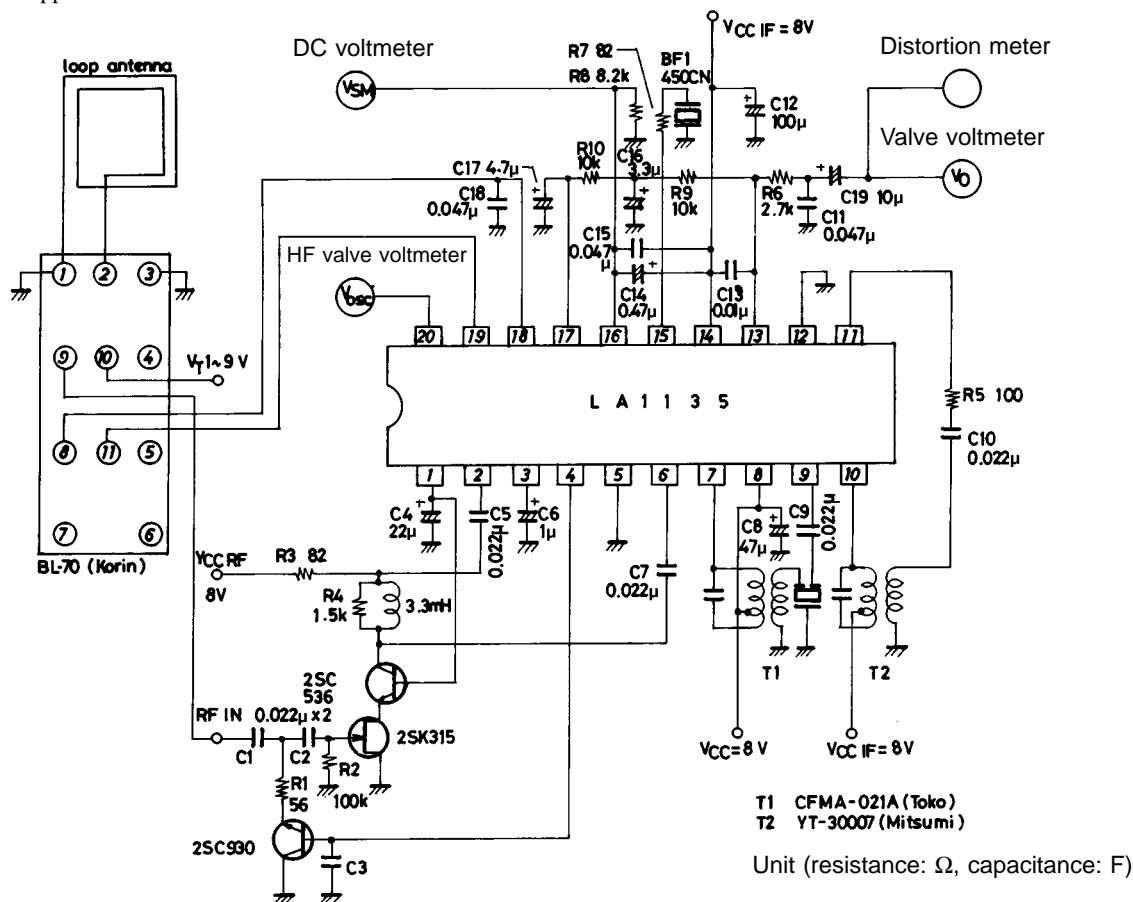

(3) Circuit configuration and connection

3-1 Circuit configuration

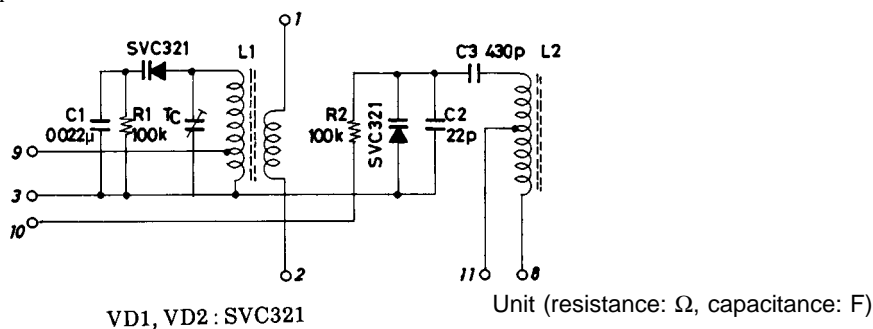

3-2 Connection (bottom view)

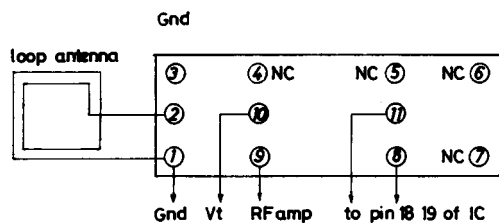



# LA1135, 1135M

## 3-3 Pin name

Pin No.	Pin Name
1	Loop ANT
2	Loop ANT
3	RF AMP GND side
4	NC
5	NC

Pin No.	Pin Name
6	NC
7	NC
8	Local OSC
9	RF output
10	Tuning voltage
11	Local OSC

## (4) Specification

Receiving frequency band	MW BAND
Tuning voltage	1 to 9 V
Loop ANT	42579719100 (LA-1500), 4257976000 (LA-100A) (Korin)
IC	LA1135

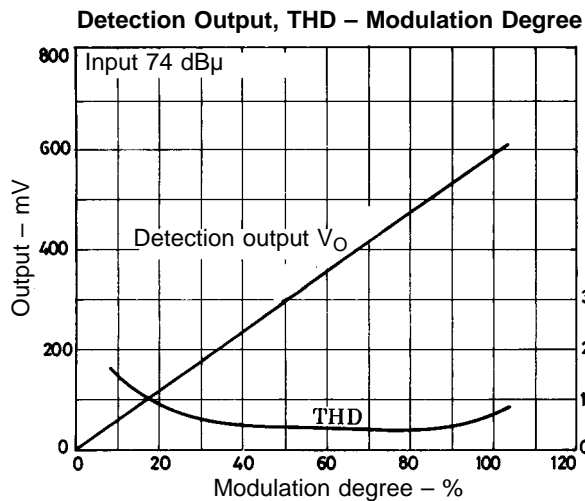
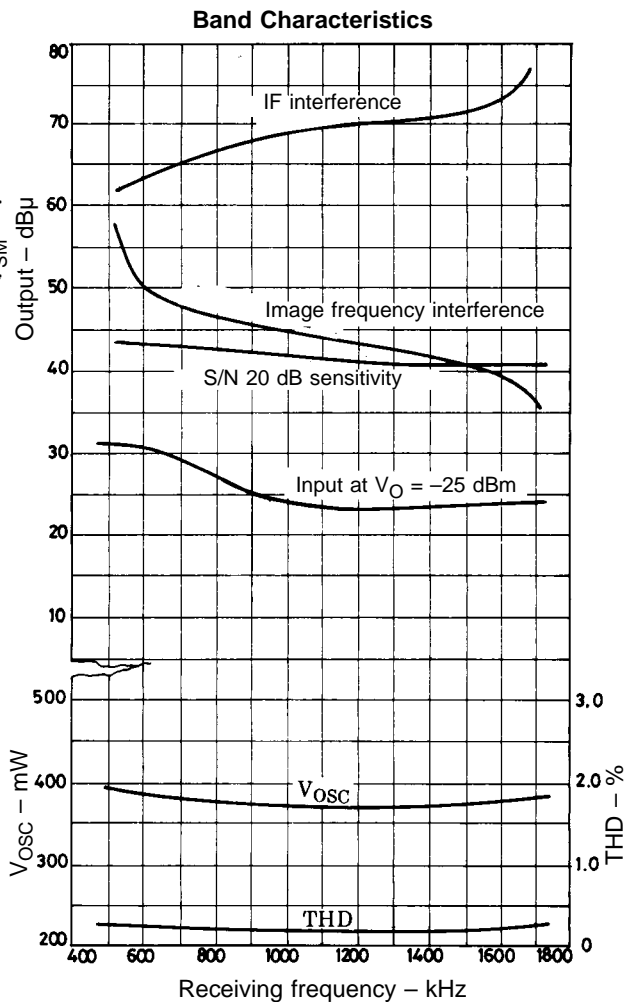
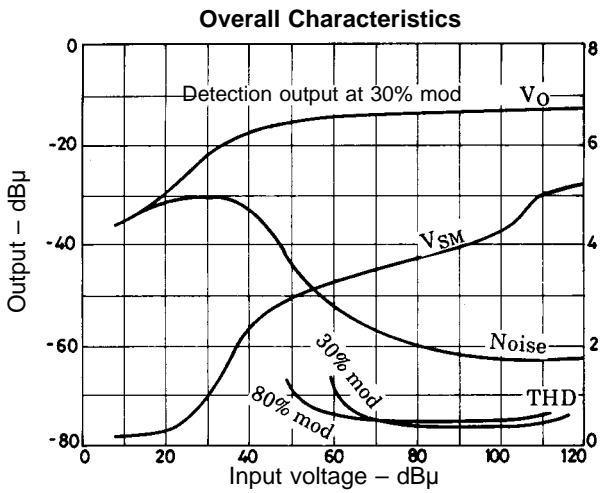

# LA1135, 1135M

### Detuning Characteristics

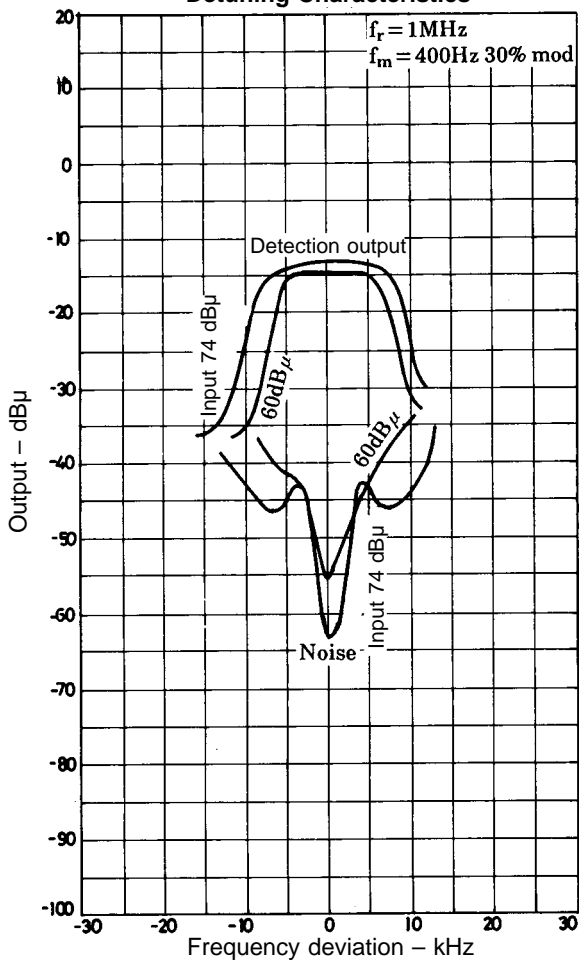

### Selectivity Characteristics

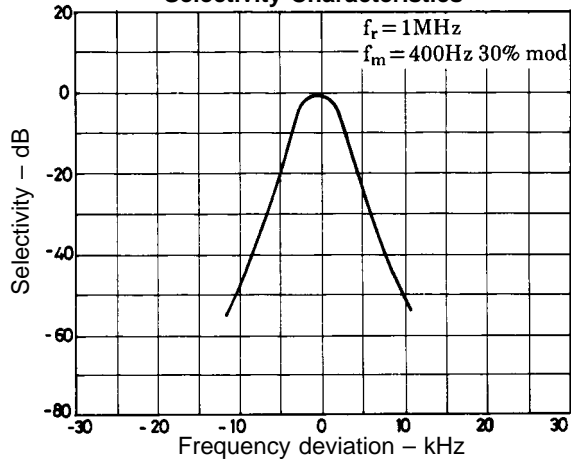

### $V_{osc} - V_{cc}$

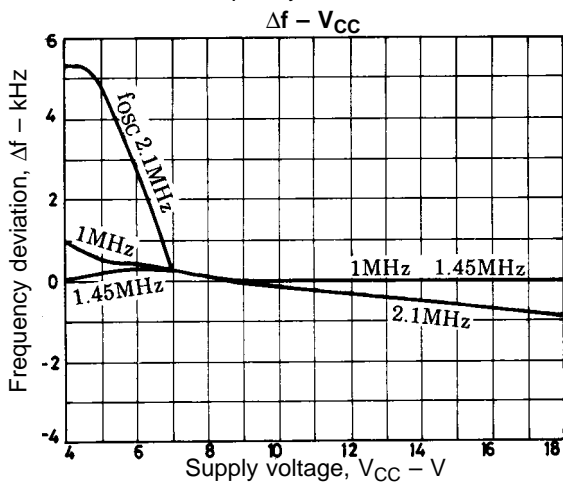
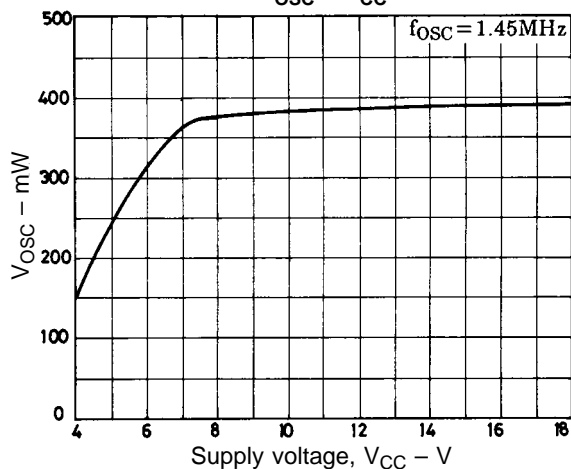

- No products described or contained herein are intended for use in surgical implants, life-support systems, aerospace equipment, nuclear power control systems, vehicles, disaster/crime-prevention equipment and the like, the failure of which may directly or indirectly cause injury, death or property loss.
- Anyone purchasing any products described or contained herein for an above-mentioned use shall:
  - ① Accept full responsibility and indemnify and defend SANYO ELECTRIC CO., LTD., its affiliates, subsidiaries and distributors and all their officers and employees, jointly and severally, against any and all claims and litigation and all damages, cost and expenses associated with such use;
  - ② Not impose any responsibility for any fault or negligence which may be cited in any such claim or litigation on SANYO ELECTRIC CO., LTD., its affiliates, subsidiaries and distributors or any of their officers and employees jointly or severally.
- Information (including circuit diagrams and circuit parameters) herein is for example only; it is not guaranteed for volume production. SANYO believes information herein is accurate and reliable, but no guarantees are made or implied regarding its use or any infringements of intellectual property rights or other rights of third parties.

This catalog provides information as of September, 1997. Specifications and information herein are subject to change without notice.