

4-channel BTL driver for CD players

BA6297AFP

The BA6297AFP is a 4-channel BTL driver for CD player actuators and motors. The preamplifier has both positive and negative input pins and output pins, making this IC suited to a broad range of applications.

● Applications

CD players

● Features

- 1) 4-channel BTL driver.
- 2) HSOP 28-pin package allows for miniaturization of applications.
- 3) Internal thermal shutdown.
- 4) Driver gain is adjustable with a single attached resistor.
- 5) Both positive and negative input pins, for adaptability for a wide range of inputs (including negative phase input).

● Block diagram

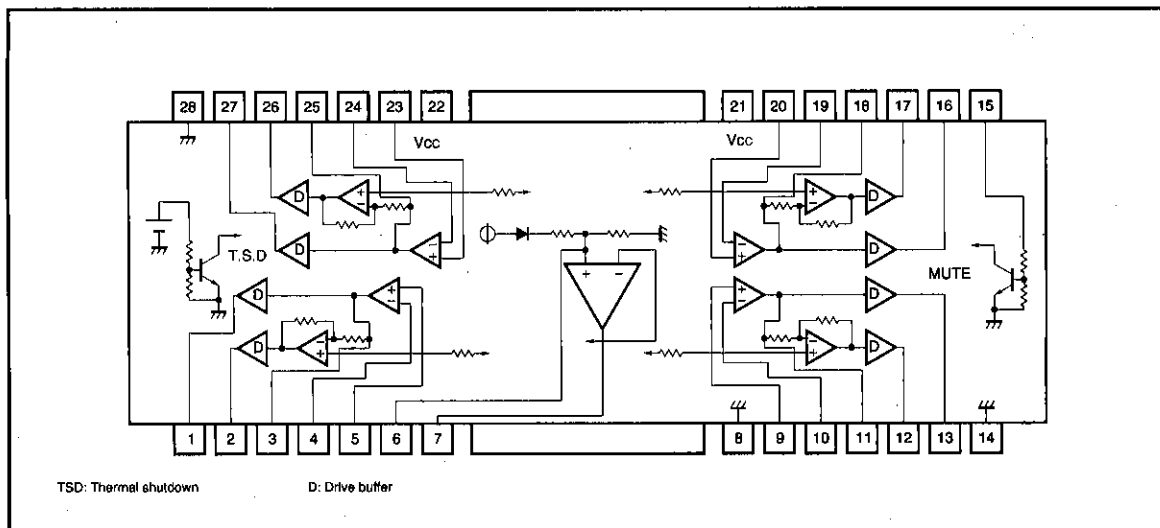

CD / CD-ROM Drivers (4 channels)

For CDs / CD-ROMs

● Absolute maximum ratings (Ta=25°C)

Parameter	Symbol	Limits	Unit
Power supply voltage	V _{CC}	18	V
Power dissipation	P _d	1.7*	W
Operating temperature range	T _{opr}	-40~80	°C
Storage temperature range	T _{stg}	-55~150	°C

* Reduced by 13.6 mW for each increase in Ta of 1°C over 25°C.

When mounted to a 50 mm × 50 mm × 1.0 mm paper phenol board

● Recommended operating conditions (Ta=25°C)

Parameter	Symbol	Min.	Typ.	Max.	Unit
Operating power supply voltage	V _{CC}	6.0	—	9.0	V

● Electrical characteristics (Unless otherwise noted, Ta=25°C, V_{CC}=8V, f=1kHz, R_L=8Ω)

Parameter	Symbol	Min.	Typ.	Max.	Unit	Conditions	Measurement Circuit
Quiescent current	I _Q	6.5	11	15.5	mA	No load	Fig.5
Output offset voltage	V _{OO}	-30	—	30	mV		
Maximum output voltage, high	V _{OHD}	5.2	5.6	—	V	V _{INDC} =1V	
Maximum output voltage, low	V _{OLD}	—	1.3	1.55	V	V _{INDC} =7V	
Input bias current	I _B	—	—	300	nA		
Synchronous input voltage	V _{ICM}	1.6	—	6.8	V	Preamplifier, buffer configured	
Preamplifier VoH	V _{OHP}	6.6	7.1	—	V	V _{INDC} =GND, R _L =∞	
Preamplifier VoL	V _{OLP}	—	0.8	1.3	V	V _{INDC} =V _{CC} , R _L =∞	
Preamplifier IoH	I _{OHP}	2	—	—	mA	Preamplifier output 100 Ω at ground	
Preamplifier IoL	I _{OLP}	5	—	—	mA	Preamplifier output 100 Ω at V _{CC}	
Ripple rejection ratio	RR	—	70	—	dB	V _{IN} =-20dBV, 100Hz	
Slew rate	SR	—	2	—	V/μs	100 KHz square wave, 3Vp-p output	
Bias pin voltage	V _{ref}	3.65	3.80	3.95	V		
Bias voltage variation	ΔV _{ref}	-30	—	25	mV	1 mA input/absorption	
Mute-off voltage	V _{MUTE}	2.0	—	—	V		

● Electrical characteristic curves

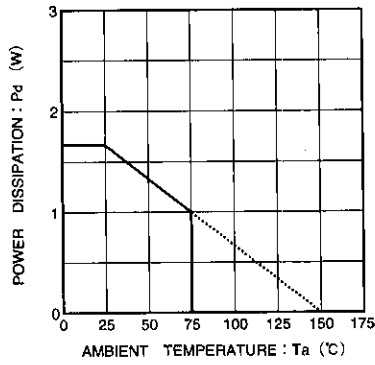

Fig. 1 Thermal derating curve

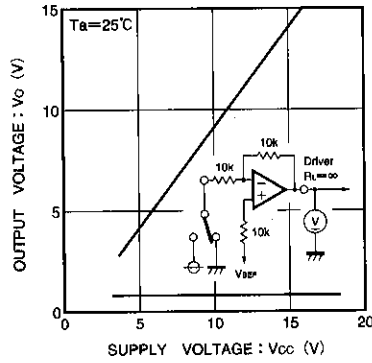

Fig. 2 Supply voltage vs. output amplitude

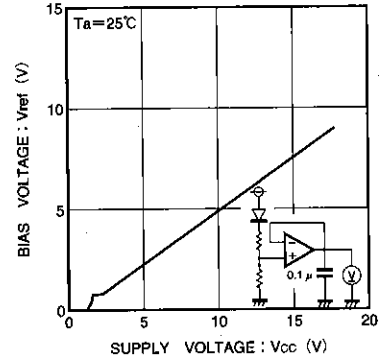

Fig. 3 Supply voltage vs. bias pin voltage

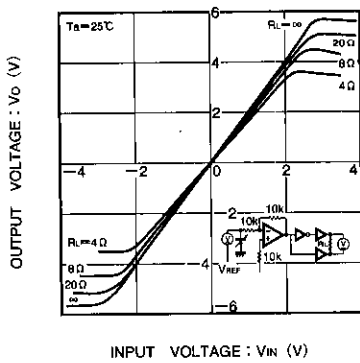

Fig. 4 Driver I/O characteristics

CD/CD-ROM Drivers (4 channels)

For CDs/CD-ROMs

● Measurement circuit

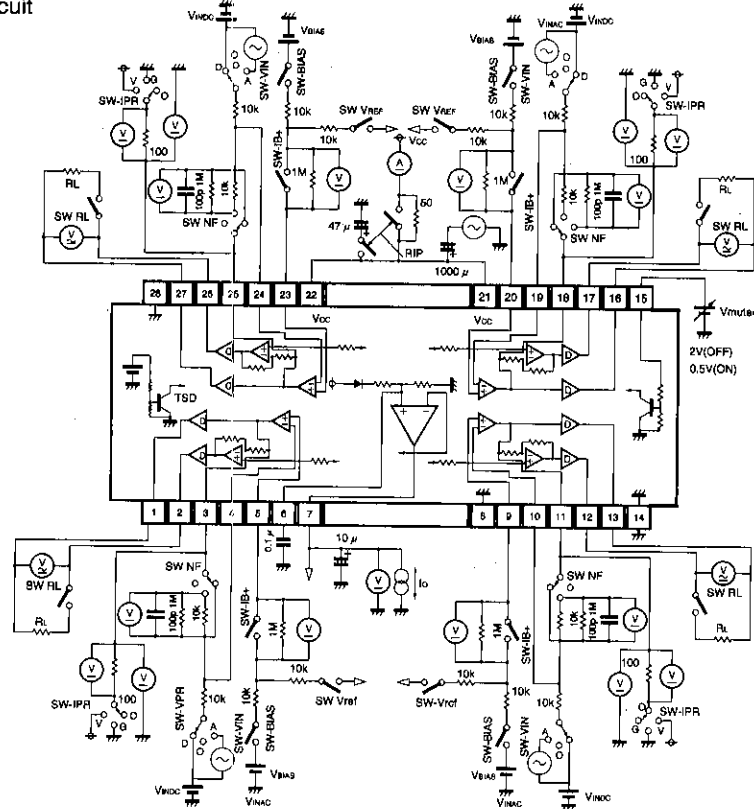

Fig. 5

Table 1 Measurement circuit switch

Parameter	Switch position								Note
	VIN	BIAS	VREF	NF	RL	IPR	Ib (+)	RIP	
Iq	D	ON	ON	10k	OFF	O	ON	ON	
Voo	↓	↓	↓	↓	ON	↓	↓	↓	
VOHD	↓	OFF	↓	↓	↓	↓	↓	↓	VINDC=1V、7V
VOLD	↓	↓	↓	↓	↓	↓	↓	↓	VINDC=1V、7V
Ib	O	↓	↓	1M	OFF	↓	OFF	↓	Both pin outputs: 1 MΩ
VicM	↓	ON	OFF	SHORT	↓	↓	ON	↓	
VOHP	↓	OFF	ON	10k	↓	↓	↓	↓	VINDC=GND
VOLP	↓	↓	↓	↓	↓	↓	↓	↓	VINDC=VCC
IOHP	↓	↓	↓	SHORT	↓	G	↓	↓	
IOLP	↓	↓	↓	↓	↓	V	↓	↓	
RR	D	ON	↓	10k	ON	O	↓	OFF	
Vref	O	↓	↓	↓	↓	↓	↓	ON	
ΔVref	↓	OFF	OFF	↓	OFF	↓	↓	↓	

* Unless otherwise noted, VBIAS = VINDC = 2.5 V

● Circuit operation

The BA6297AFP comprises a 4-channel driver, internal bias amplifier, mute pin and thermal shutdown.

(1) Driver

The driver uses a buffer to output one of the outputs from its preamplifier with no modification, and uses an inversion amplifier to invert the other output before sending it to the driver buffer. The inversion amplifier's reference is the bias voltage generated internally (pin 7 voltage), and so the preamplifier output must make the zero level equal to the internal bias voltage. See Figs. 7 and 8 for examples.

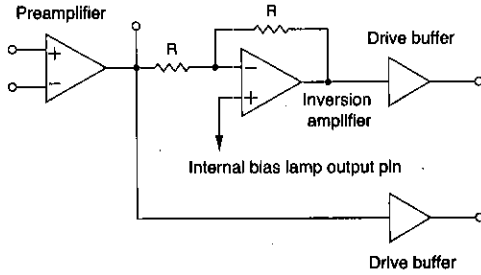

Fig. 6 Driver block

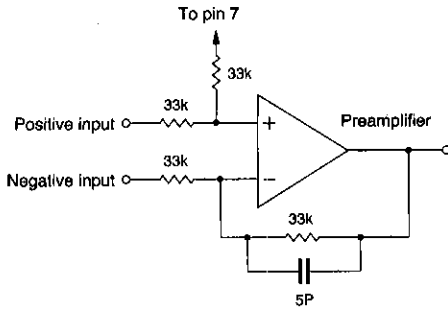

Fig. 7 Differential input

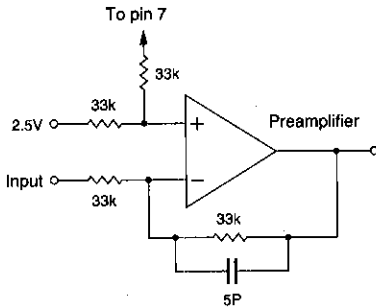

Fig. 8 Input centered on 2.5 V

(2) Internal bias amplifier

Configured as shown in Fig. 9. The internal bias voltage (V_{ref}) is calculated thus :

$$V_{ref} = \frac{V_{CC} - V_F}{2}$$

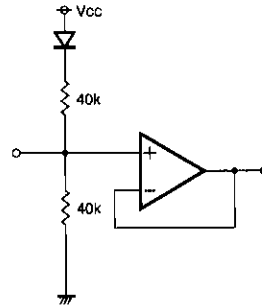

Fig. 9 Internal bias block

(3) Mute pin (15 pin)

The output current is muted when this pin receives the low level or a high impedance. Set the pin voltage at high during normal operation.

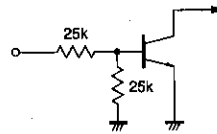

Fig. 10 The mute pin

(4) Thermal shutdown

The BA6297AFP has an internal thermal shutdown circuit. Output current is muted when the chip temperature exceeds 175°C (typically).

CD/CD-ROM Drivers (4 channels)

For CDs/CD-ROMs

● Operation notes

- (1) The BA6297AFP has an internal thermal shut-down circuit. Output current is muted when the chip temperature exceeds 175°C (typically).
- (2) If the mute pin (15 pin) voltage is opened or lowered below 0.5V, the output current will be muted. Pin 2 should be pulled up above 2.0V during normal use. During muting, the output pins remain at the internal bias voltage, roughly $(V_{CC}-V_F)/2$.

- (3) Be sure to connect the IC to a 0.1 μF bypass capacitor to the power supply, at the base of the IC.
- (4) The radiating fin is connected to the package's internal GND, but should also be connected to an external ground.

● Application example

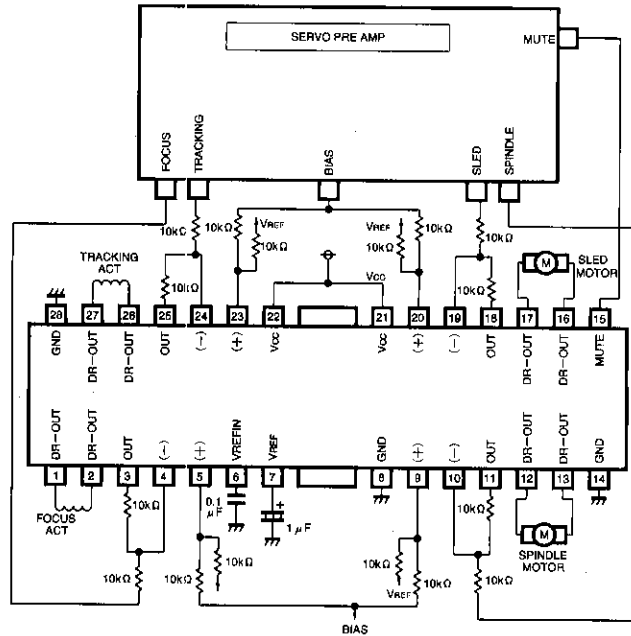

Fig. 11

● External dimensions (Units: mm)

