

# TA8211AH

## Dual Audio Power Amplifier

The TA8211AH is dual audio power amplifier for consumer applications.

This IC provides an output power of 6 watts per channel (at  $V_{CC} = 20\text{ V}$ ,  $f = 1\text{ kHz}$ ,  $\text{THD} = 10\%$ ,  $R_L = 8\ \Omega$ ).

It is suitable for power amplifier of TV and home stereo.

### Features

- High output power:  $P_{out} = 6\text{ W/channel}$  (Typ.)  
( $V_{CC} = 20\text{ V}$ ,  $R_L = 8\ \Omega$ ,  $f = 1\text{ kHz}$ ,  $\text{THD} = 10\%$ )
- Low noise:  $V_{no} = 0.14\text{ mVrms}$  (Typ.)  
( $V_{CC} = 28\text{ V}$ ,  $R_L = 8\ \Omega$ ,  $G_v = 34\text{ dB}$ ,  $R_g = 10\text{ k}\Omega$ ,  $\text{BW} = 20\text{ Hz}\sim 20\text{ kHz}$ )
- Very few external parts
- Built in thermal shut down protector circuit
- Operating supply voltage range:  $V_{CC}(\text{opr}) = 10\sim 30\text{ V}$  ( $T_a = 25^\circ\text{C}$ )

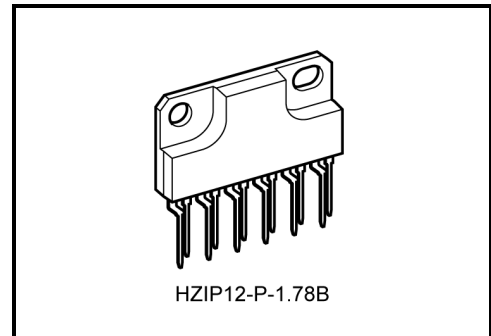

Weight: 4.04 g (typ.)

### Block Diagram

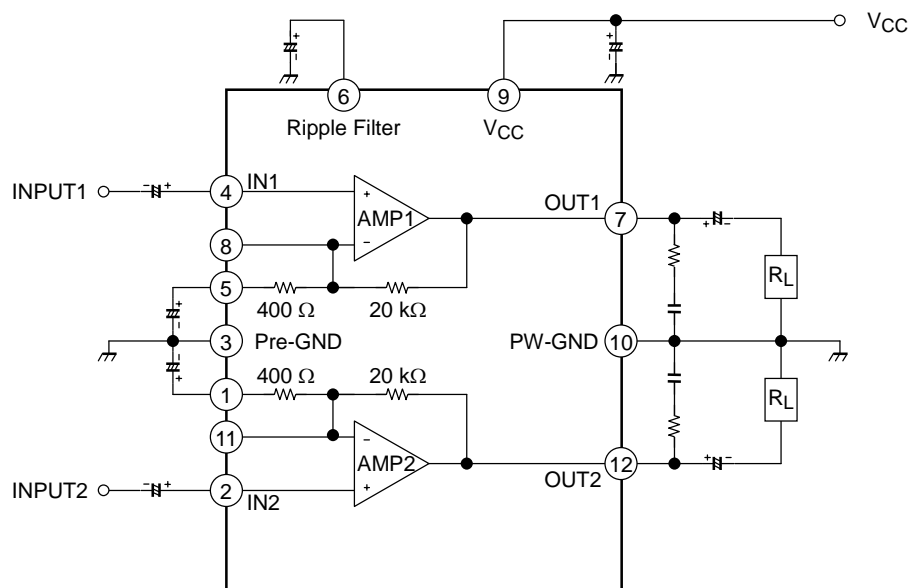

**Application Information**

**Voltage gain**

The closed loop voltage gain is determined by R<sub>1</sub>, R<sub>2</sub>.

$$G_V = 20 \log \frac{R_1 + R_2}{R_2} \text{ (dB)}$$

$$= 20 \log \frac{20 \text{ k}\Omega + 400 \Omega}{400 \Omega}$$

$$\approx 34 \text{ (dB)}$$

(a) Amplifier with gain > 34dB

$$G_V = 20 \log \frac{R_1 + R_2 // R_3}{R_2 // R_3} \text{ (dB)}$$

When R<sub>3</sub> = 400 Ω  
 G<sub>V</sub> ≈ 40 (dB)  
 is given.

(b) Amplifier with gain < 34dB

$$G_V = 20 \log \frac{R_1 + R_2 + R_4}{R_2 + R_4} \text{ (dB)}$$

When R<sub>4</sub> = 220 Ω  
 G<sub>V</sub> ≈ 30 (dB)  
 is given.

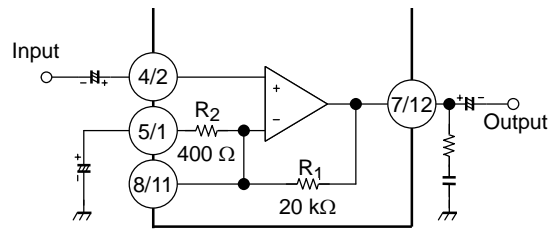

**Figure 1**

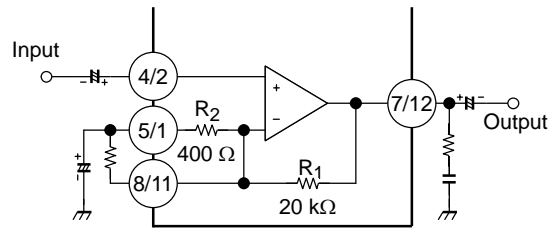

**Figure 2**

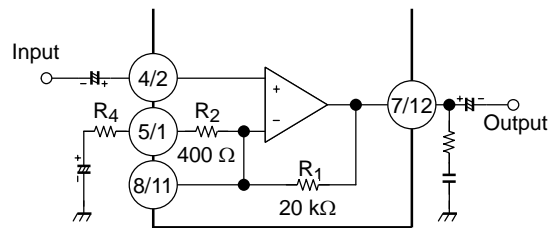
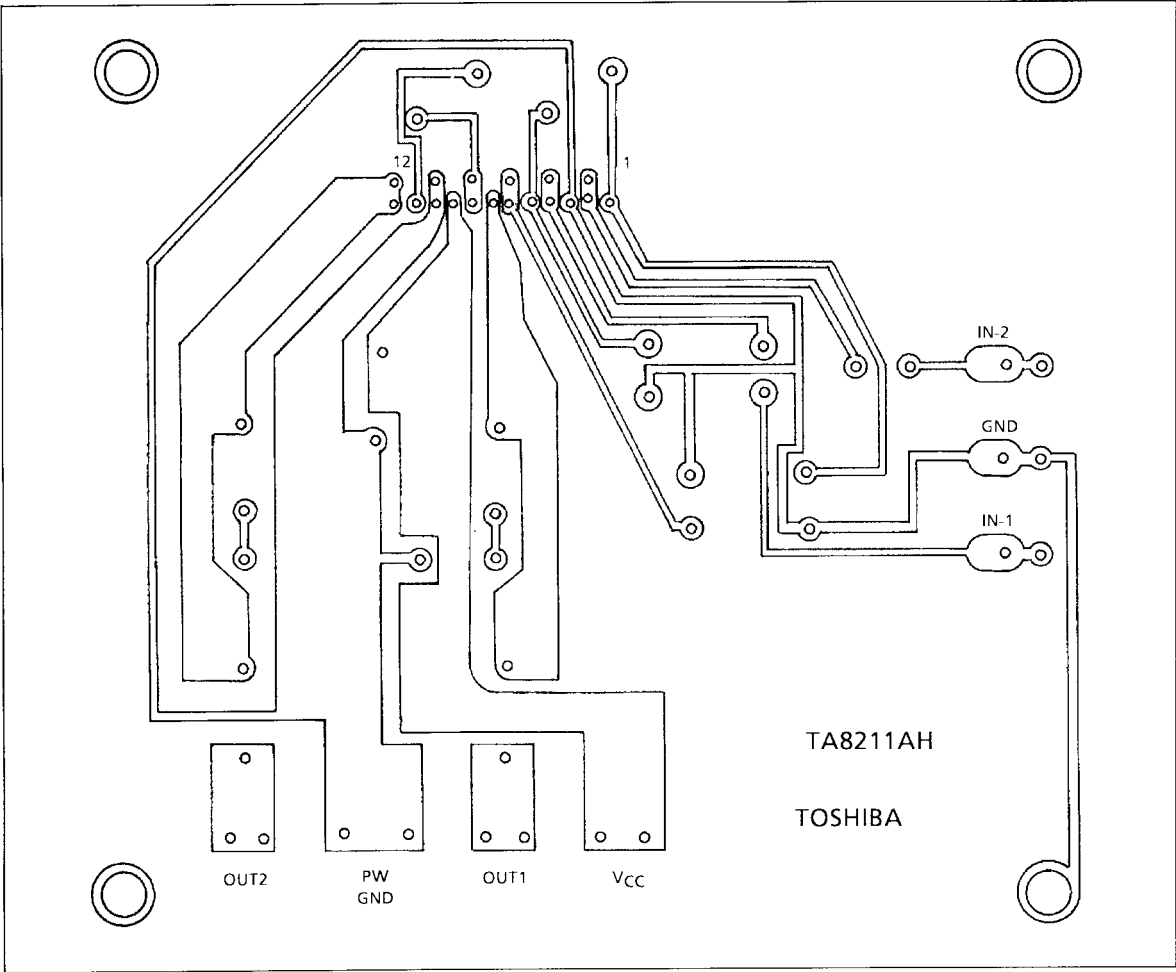

**Figure 3**

**Cautions**

This IC is not proof enough against a strong E-M field by CRT which may cause malfunction such as leak. Please set the IC keeping the distance from CRT.

Standard PCB



(Bottom view)

## Maximum Ratings (Ta = 25°C)

Characteristics	Symbol	Rating	Unit
Supply voltage	V <sub>CC</sub>	30	V
Output current (Peak/ch)	I <sub>O (peak)</sub>	2	A
Power dissipation	P <sub>D (Note)</sub>	25	W
Operating temperature	T <sub>opr</sub>	-20~75	°C
Storage temperature	T <sub>stg</sub>	-55~150	°C

Note: Derated above Ta = 25°C in the proportion of 200 mW/°C.

## Electrical Characteristics

(unless otherwise specified, V<sub>CC</sub> = 20 V, R<sub>L</sub> = 600 Ω, R<sub>g</sub> = 600 Ω, f = 1 kHz, Ta = 25°C)

Characteristics	Symbol	Test Circuit	Test Condition	Min	Typ.	Max	Unit
Quiescent current	I <sub>CCQ</sub>	—	V <sub>in</sub> = 0	—	75	130	mA
Output power	P <sub>out (1)</sub>	—	THD = 10%	5.0	6.0	—	W
	P <sub>out (2)</sub>	—	THD = 1%	—	4.5	—	
Total harmonic distortion	THD	—	P <sub>out</sub> = 2 W	—	0.1	0.6	%
Closed loop voltage gain	G <sub>V</sub>	—	V <sub>out</sub> = 0.775 V <sub>rms</sub> (0dBm)	32.5	34.0	35.5	dB
Open loop voltage gain	G <sub>VO</sub>	—	—	—	60	—	dB
Input resistance	R <sub>IN</sub>	—	—	—	30	—	kΩ
Ripple rejection ratio	R.R.	—	R <sub>g</sub> = 0, f <sub>ripple</sub> = 100 Hz V <sub>ripple</sub> = 0.775 V <sub>rms</sub> (0dBm)	-45	-57	—	dB
Output noise voltage	V <sub>no</sub>	—	R <sub>g</sub> = 10 kΩ, BW = 20 Hz~20 kHz	—	0.14	0.3	mV <sub>rms</sub>

## Typ. DC Voltage of Each Terminal (V<sub>CC</sub> = 20 V, Ta = 25°C)

Terminal No.	1	2	3	4	5	6	7	8	9	10	11	12
DC voltage (V)	2.1	2.25	GND	2.25	2.1	6.8	9.8	2.25	V <sub>CC</sub>	GND	2.25	9.8

## Test Circuit

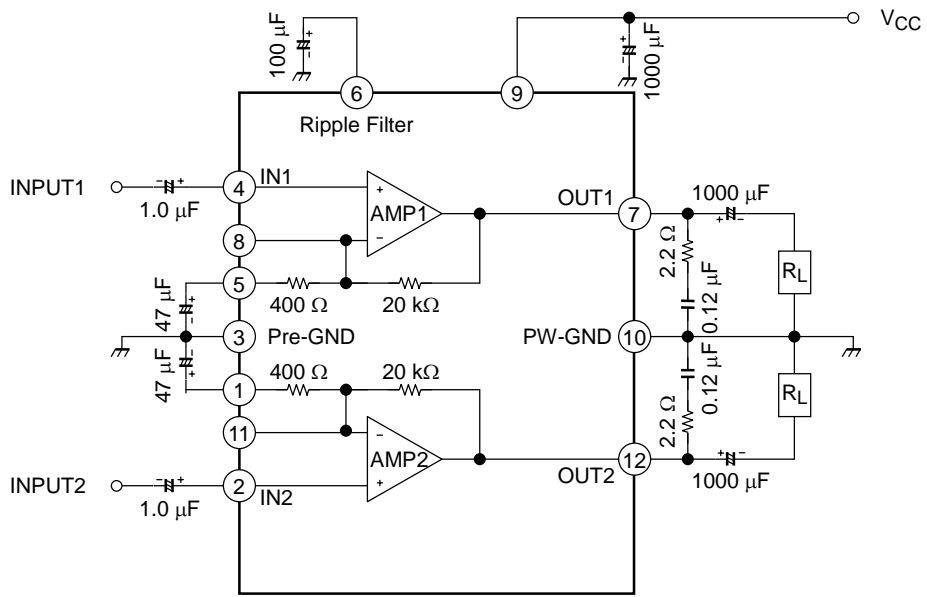

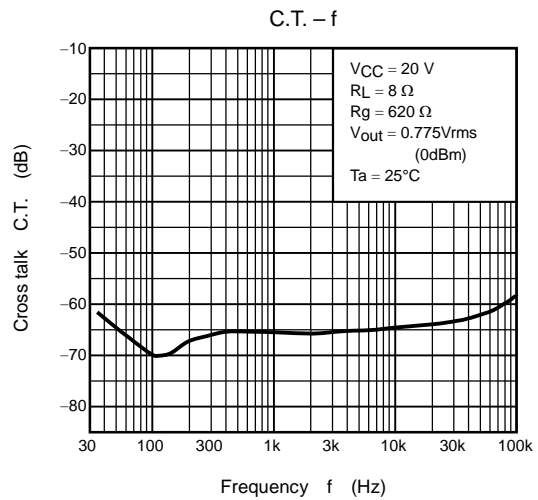
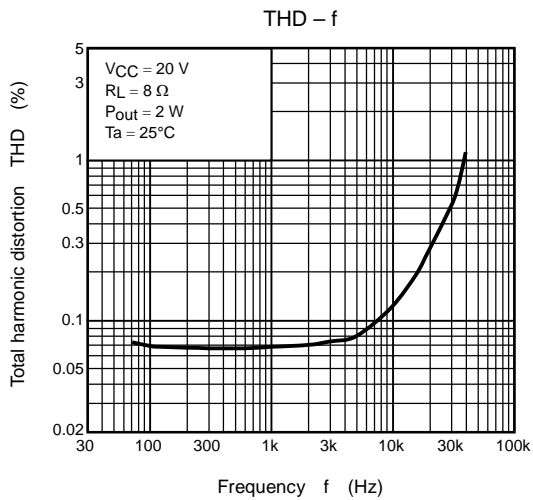
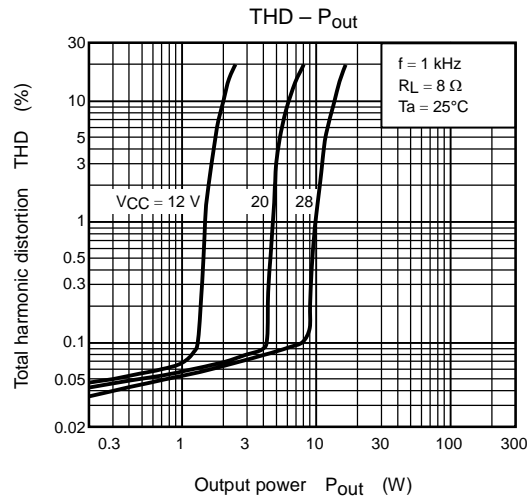
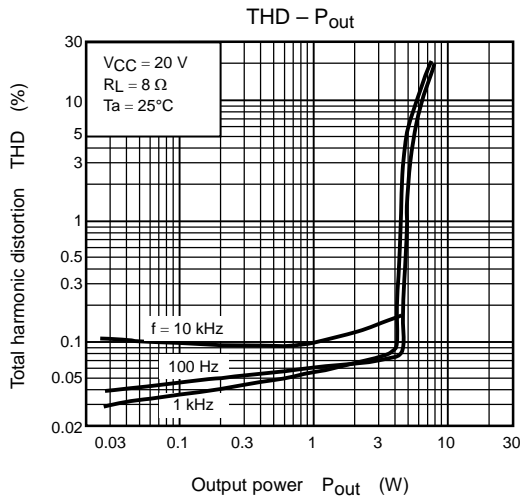
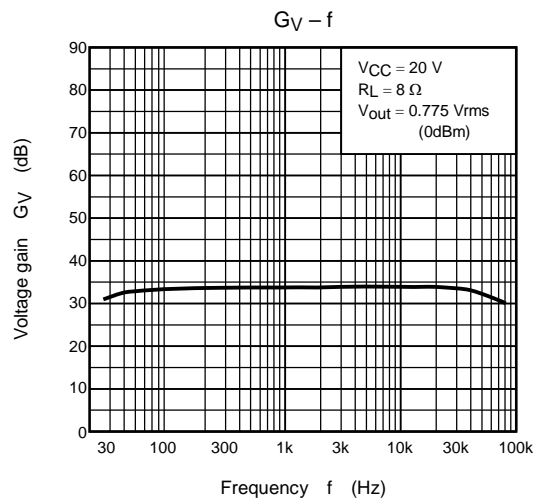
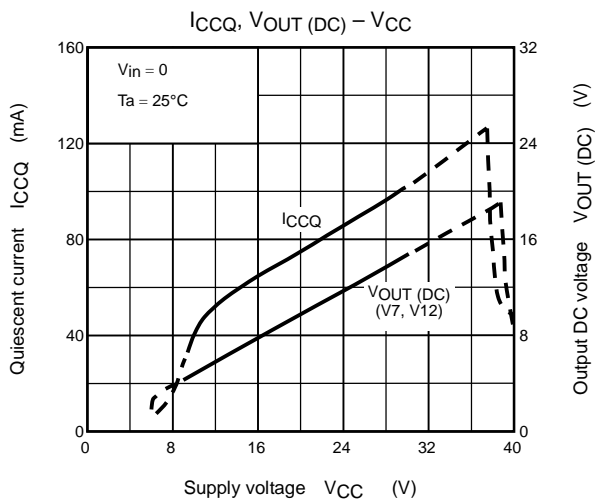

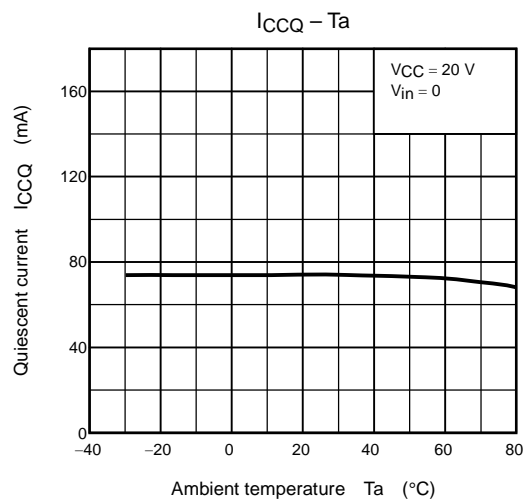
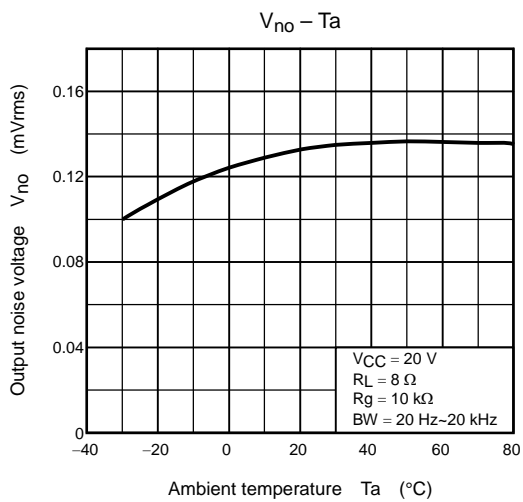
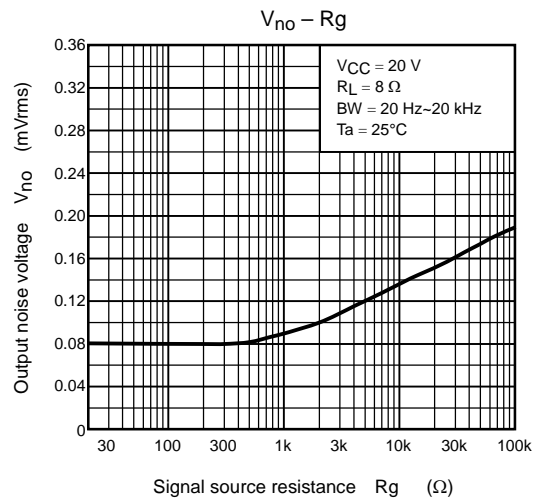
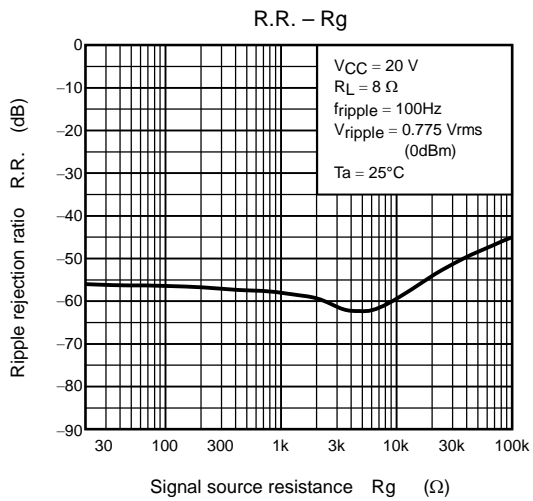
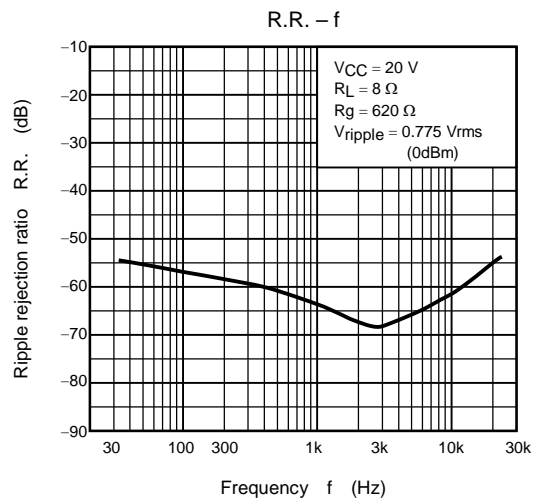
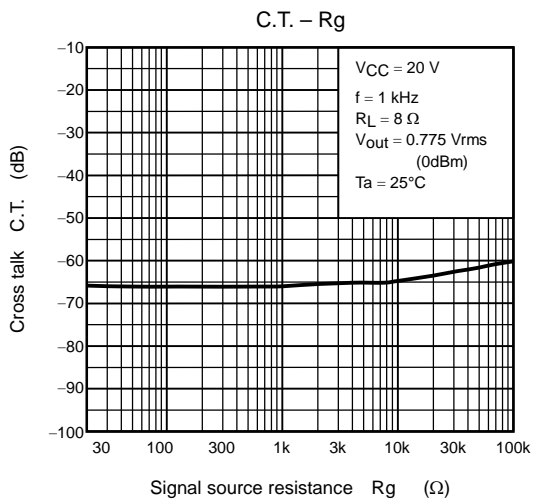

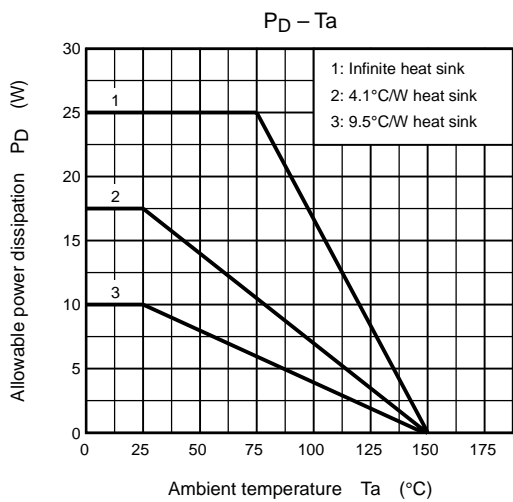
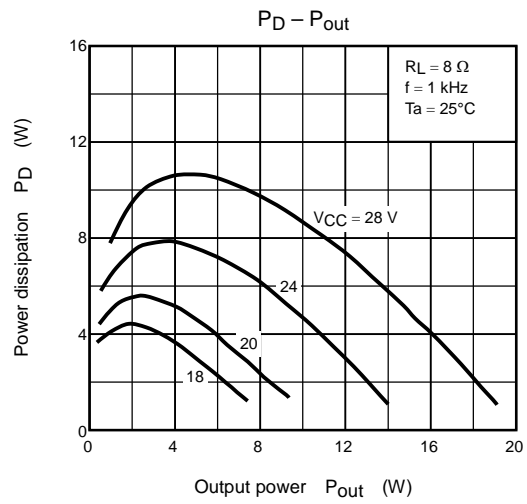
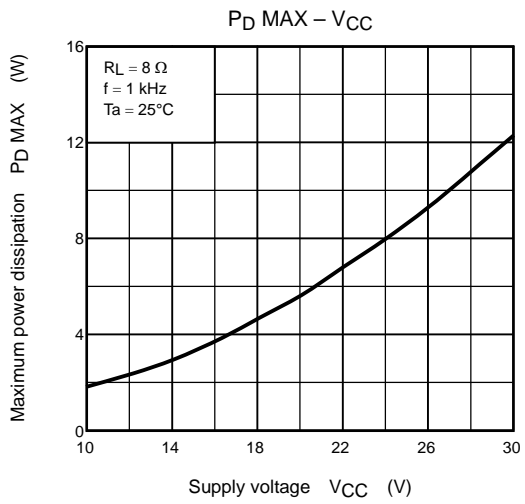
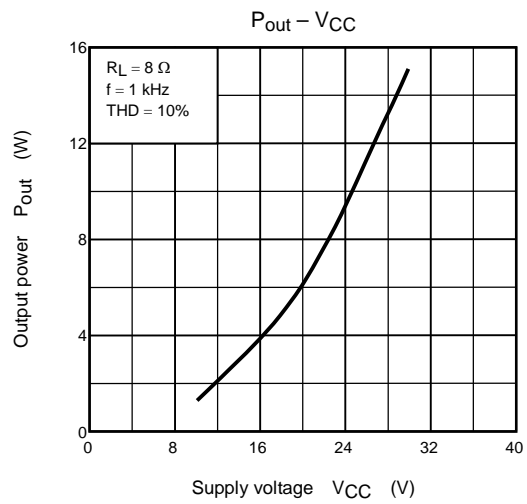
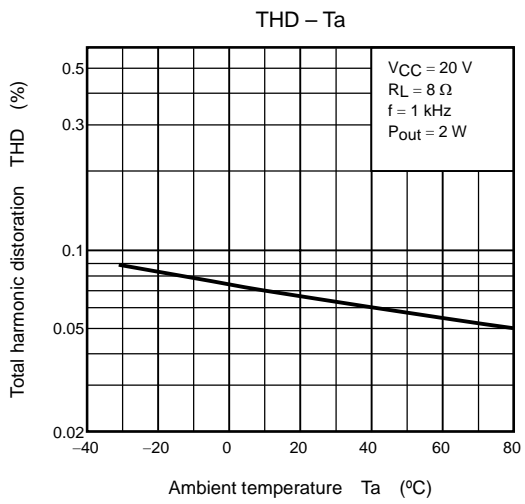



**Package Dimensions**

HZIP12-P-1.78B

Unit: mm

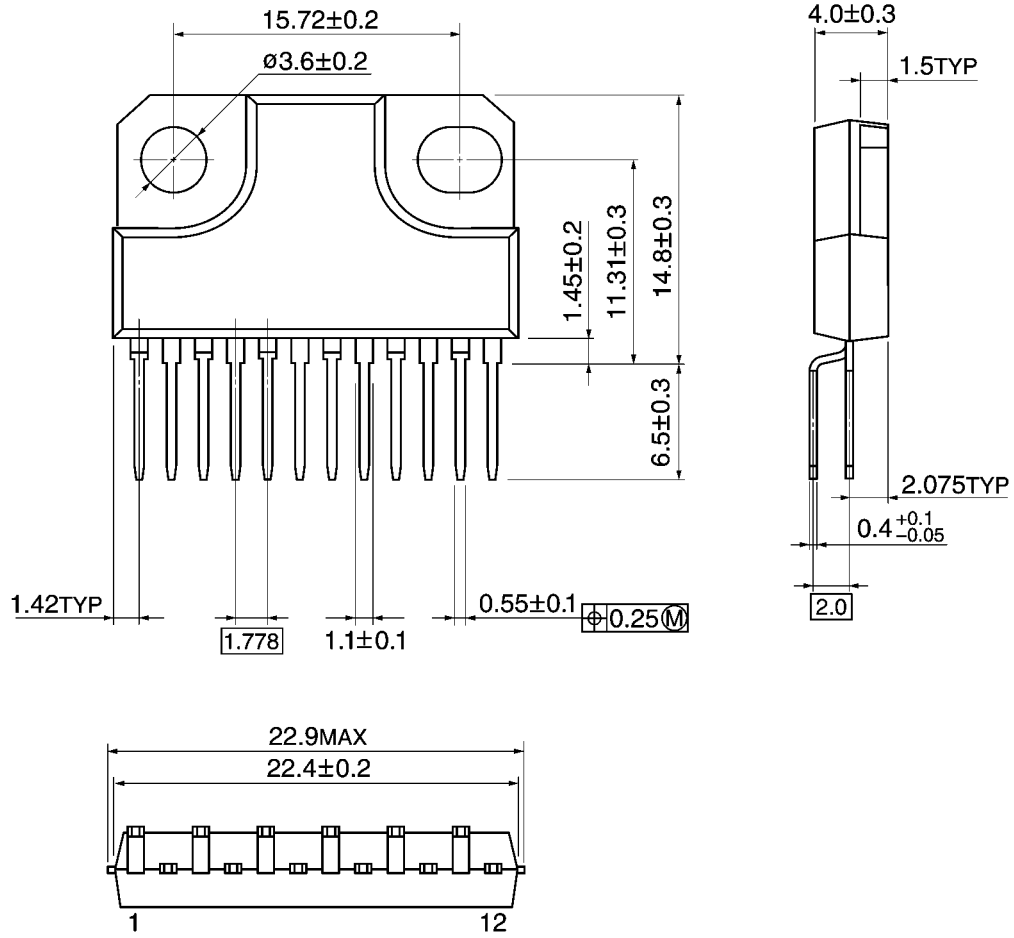

Weight: 4.04 g (typ.)

**RESTRICTIONS ON PRODUCT USE**

000707EBF

- TOSHIBA is continually working to improve the quality and reliability of its products. Nevertheless, semiconductor devices in general can malfunction or fail due to their inherent electrical sensitivity and vulnerability to physical stress. It is the responsibility of the buyer, when utilizing TOSHIBA products, to comply with the standards of safety in making a safe design for the entire system, and to avoid situations in which a malfunction or failure of such TOSHIBA products could cause loss of human life, bodily injury or damage to property.  
In developing your designs, please ensure that TOSHIBA products are used within specified operating ranges as set forth in the most recent TOSHIBA products specifications. Also, please keep in mind the precautions and conditions set forth in the "Handling Guide for Semiconductor Devices," or "TOSHIBA Semiconductor Reliability Handbook" etc..
- The TOSHIBA products listed in this document are intended for usage in general electronics applications (computer, personal equipment, office equipment, measuring equipment, industrial robotics, domestic appliances, etc.). These TOSHIBA products are neither intended nor warranted for usage in equipment that requires extraordinarily high quality and/or reliability or a malfunction or failure of which may cause loss of human life or bodily injury ("Unintended Usage"). Unintended Usage include atomic energy control instruments, airplane or spaceship instruments, transportation instruments, traffic signal instruments, combustion control instruments, medical instruments, all types of safety devices, etc.. Unintended Usage of TOSHIBA products listed in this document shall be made at the customer's own risk.
- This product generates heat during normal operation. However, substandard performance or malfunction may cause the product and its peripherals to reach abnormally high temperatures.  
The product is often the final stage (the external output stage) of a circuit. Substandard performance or malfunction of the destination device to which the circuit supplies output may cause damage to the circuit or to the product.
- The products described in this document are subject to the foreign exchange and foreign trade laws.
- The information contained herein is presented only as a guide for the applications of our products. No responsibility is assumed by TOSHIBA CORPORATION for any infringements of intellectual property or other rights of the third parties which may result from its use. No license is granted by implication or otherwise under any intellectual property or other rights of TOSHIBA CORPORATION or others.
- The information contained herein is subject to change without notice.