

Features

1. Mini-flat package.
2. High collector-emitter voltage (V_{CEO}:300V)
3. High current transfer ratio (CTR:MIN.1000% at I_F=1mA, V_{CE}:2V)
4. High isolation voltage between input and output (Viso:3750Vrms).

Applications

1. Telephone sets.
2. Copiers, facsimiles.
3. Interfaces with various power supply circuits, power distribution boards.
4. Hybrid substrates which require high density mounting.

Outside Dimension : Unit (mm)

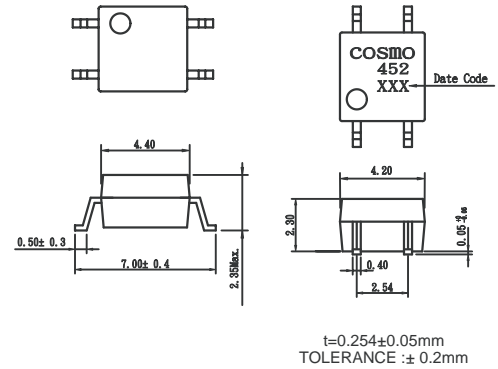

Schematic : Top View

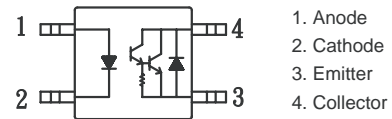

Absolute Maximum Ratings

(Ta=25°C)

Parameter		Symbol	Rating	Unit
Input	Forward current	I _F	50	mA
	Peak forward current	I _{FM}	1	A
	Reverse voltage	V _R	6	V
	Power dissipation	P	70	mW
Output	Collector-emitter voltage	V _{CEO}	300	V
	Emitter-collector voltage	V _{ECO}	0.1	V
	Collector current	I _C	150	mA
	Collector power dissipation	P _C	150	mW
Total power dissipation		P _{tot}	170	mW
Isolation voltage 1 minute		V _{iso}	3750	V _{rms}
Operating temperature		T _{opr}	-30 to +100	°C
Storage temperature		T _{stg}	-40 to +125	°C
Soldering temperature 10 seconds		T _{sol}	260	°C

Electro-optical Characteristics

(Ta=25°C)

Parameter		Symbol	Conditions	MIN.	TYP.	MAX.	Unit
Input	Forward voltage	V _F	I _F =10mA	—	1.2	1.4	V
	Reverse current	I _R	V _R =4V	—	—	10	uA
	Terminal capacitance	C _t	V=0, f=1kHz	—	30	—	pF
Output	Collector dark current	I _{CEO}	V _{CE} =200V, I _F =0	—	—	1	uA
	Collector-emitter breakdown voltage	BV _{CEO}	I _C =0.1mA, I _F =0	300	—	—	V
Transfer characteristics	Current transfer ratio	CTR	I _F =1mA, V _{CE} =2V	1000	—	—	%
	Collector-emitter saturation voltage	V _{CE (sat)}	I _F =20mA, I _C =100mA	—	—	1.5	V
	Isolation resistance	R _{iso}	DC500V, 40 TO 60%RH	5X10 ¹⁰	10 ¹¹	—	ohm
	Floating capacitance	C _f	V=0, f=1MHZ	—	0.6	1.0	pF
	Response time (Rise)	t _r	V _{CE} =2V, I _C =20mA, R _L =100ohm	—	100	300	us
	Response time (Fall)	t _f		—	20	100	us

Fig.1 Forward Current vs. Ambient Temperature

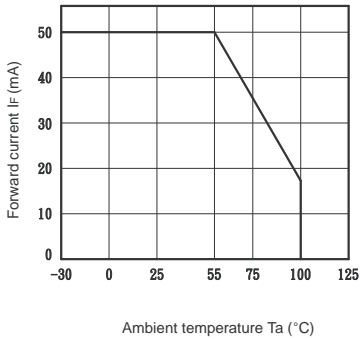

Fig.2 Collector Power Dissipation vs. Ambient Temperature

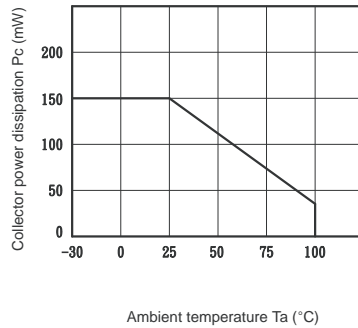

Fig.3 Peak Forward Current vs. Duty Ratio

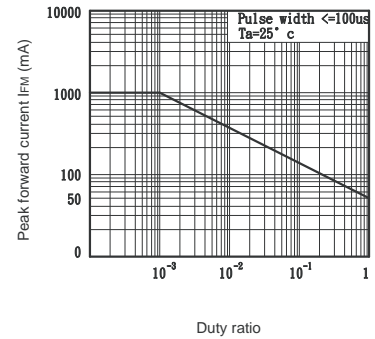

Fig.4 Forward Current vs. Forward Voltage

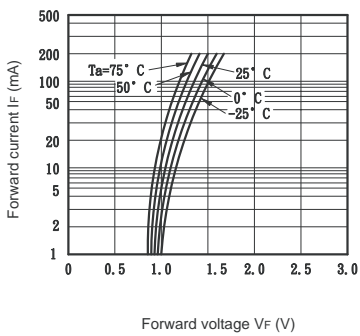

Fig.5 Current Transfer Ratio vs. Forward Current

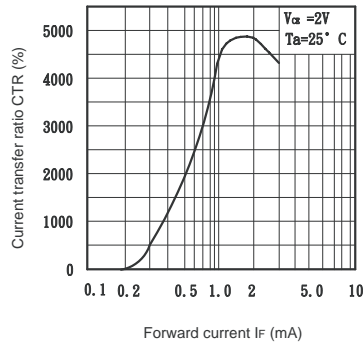

Fig.6 Collector Current vs. Collector-emitter Voltage

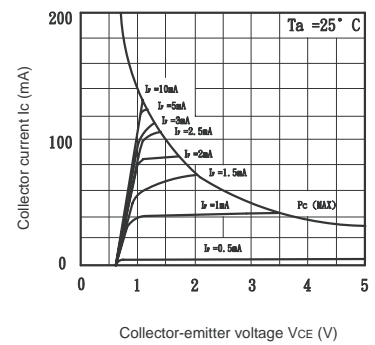

Fig.7 Relative Current Transfer Ratio vs. Ambient Temperature

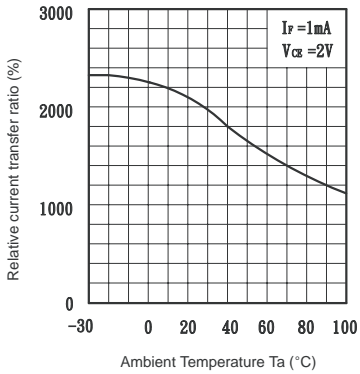

Fig.8 Collector-emitter Saturation Voltage vs. Ambient Temperature

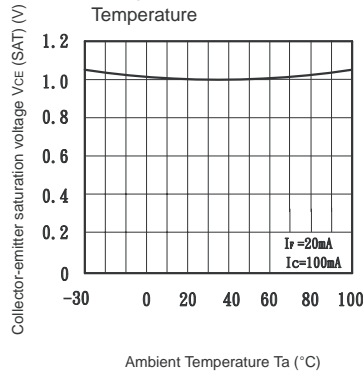

Fig.9 Collector Dark Current vs. Ambient Temperature

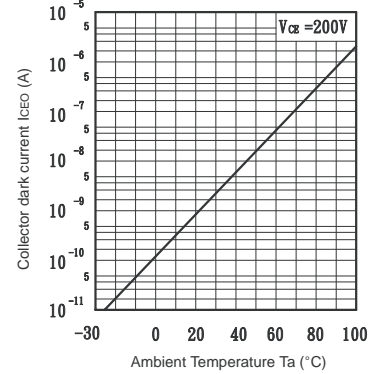

Fig.10 Response Time vs. Load Resistance

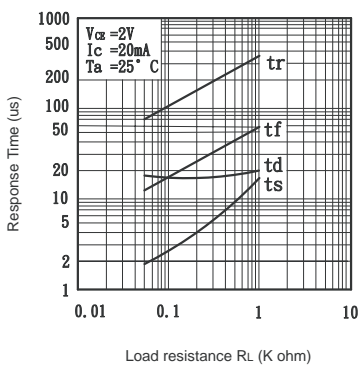

Fig.11 Frequency Response

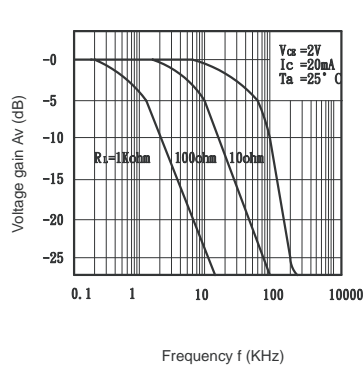

Fig.12 Collector-emitter Saturation Voltage vs. Forward current

