



MEAN WELL

SWITCHING POWER SUPPLY

ISO-9001 CERTIFIED MANUFACTURER

DR-120 SERIES

- .LOW COST, HIGH RELIABILITY
- .105°C OUTPUT CAPACITOR
- .INTERNATIONAL AC INPUT RANGE
- .HIGH EFFICIENCY, LOW WORKING TEMPERATURE
- .SOFT-START CIRCUIT, LIMITING AC SURGE CURRENT
- .SHORT CIRCUIT, OVERLOAD, OVER VOLTAGE PROTECTED
- .COMPACT SIZE, LIGHT WEIGHT
- .100% FULL LOAD BURN-IN TEST
- .BUILT IN EMI FILTER, LOW RIPPLE NOISE



MODEL	DR-120-12	DR-120-24	DR-120-48
SPECIFICATION			
DC OUTPUT VOLTAGE	12V	24V	48V
OUTPUT V. TOLERANCE	±2%	±1%	±1%
OUTPUT RATED CURRENT	10A	5A	2.5A
OUTPUT CURRENT RANGE	0-10A	0-5A	0-2.5A
RIPPLE & NOISE	80mVp-p	80mVp-p	100mVp-p
LINE REGULATION	±0.5%	±0.5%	±0.5%
LOAD REGULATION	±1%	±1%	±1%
DC OUTPUT POWER	120W	120W	120W
EFFICIENCY	80%	84%	85%
DC VOLTAGE ADJ.	12-14V	24-28V	48-53V
INPUT VOLTAGE RANGE	88-132VAC/176-264VAC BY SWITCH 47-63Hz ; 254-370VDC		
AC CURRENT	2.8A/115V 1.7A/230V		
INRUSH CURRENT	COLD START 30A/115V 60A/230V		
LEAKAGE CURRENT	<3.5mA/240VAC		
OVERLOAD PROTECTION	105%-150% TYPE:CONSTANT CURRENT LIMITING RESET:AUTO RECOVERY		
OVER VOLTAGE PROTECTION	15-16.5V	29-33V	58-65V
OVER TEMP.PROTECTION	85 °C±5 °C(TSW1)	90 °C±5 °C TYPE:SHUT DOWN RESET:AUTO RECOVERY(TSW1)	
TEMP. COEFFICIENT	±0.03% / °C (0-50°C)		
SETUP, RISE, HOLD UP TIME	500ms;70ms; 30ms/230V,115V		
VIBRATION	10-500Hz, 2G 10min./1cycle, PERIOD FOR 60min. EACH AXES		
WITHSTAND VOLTAGE	I/P-O/P:3KVAC I/P-FG:1.5KVAC O/P-FG:0.5KVAC		
ISOLATION RESISTANCE	I/P-O/P, I/P-FG, O/P-FG:500VDC / 100M Ohms		
WORKING TEMP., HUMIDITY	-10°C~+60°C(REFER TO OUTPUT DERATING CURVE), 20%-90% RH		
STORAGE TEMP., HUMIDITY	-20°C~+85°C, 10%-95% RH		
DIMENSION	65.5*125.2*100mm (W*H*D)		
WEIGHT	0.65Kgs		
SAFETY STANDARDS	TUV EN60950, UL508 APPROVED		
EMC STANDARDS	EN55022 CLASS B, EN61000-4-2,3,4,5,6,8,11; ENV50204, EN61000-3-2,-3 VERIFICATION		

NOTE : 1.ALL PARAMETERS ARE SPECIFIED AT 230VAC INPUT, RATED LOAD, 25°C 70% RH. AMBIENT.
 2.TOLERANCE : INCLUDE SET UP TOLERANCE, LINE REGULATION, LOAD REGULATION.
 3.RIPPLE & NOISE ARE MEASURED AT 20MHz BY USING A 12" TWISTED PAIR TERMINATED WITH A 0.1uF & 47uF CAPACITOR.

4.LINE REGULATION IS MEASURED FROM LOW LINE TO HIGH LINE AT RATED LOAD.
 5.LOAD REGULATION IS MEASURED FROM 0% TO 100% RATED LOAD.

BLOCK DIAGRAM

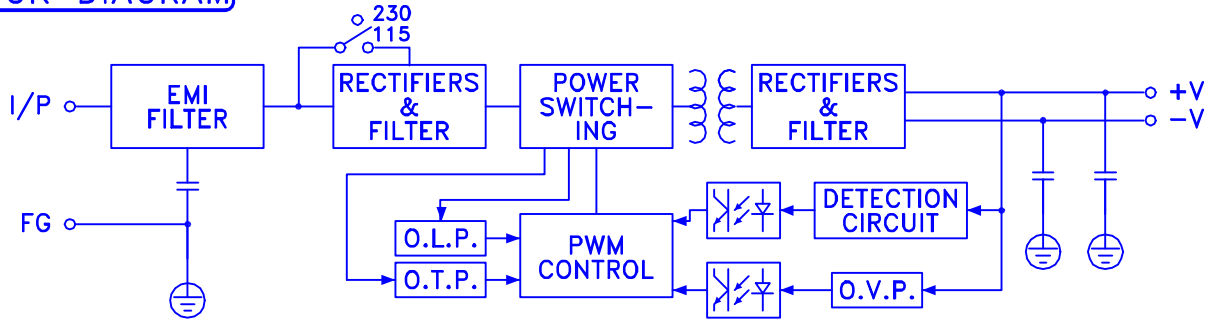

fosc : 55KHz

OUTPUT DERATING

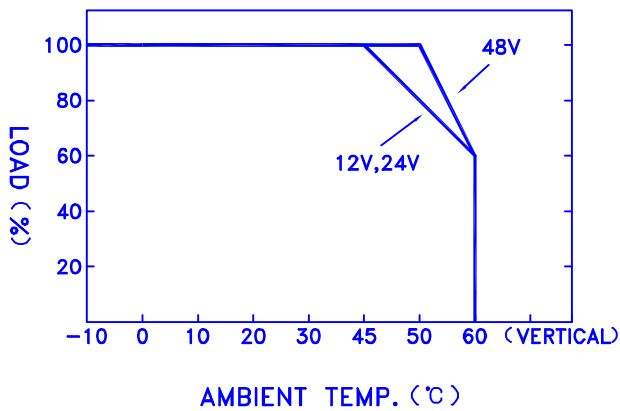

STATIC CHARACTERISTICS

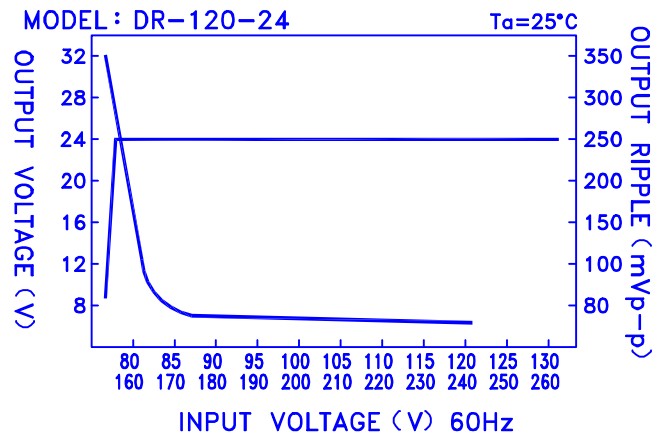

DIMENSION (mm)

- ☒ CASE : 921
- ☒ TERMINAL PIN NO. ASSIGNMENT
 - ☒ TB1 : AC INPUT
 - ☒ PIN 1 : ⊕
 - ☒ PIN 2 : AC/N
 - ☒ PIN 3 : AC/L
 - ☒ TB2 : DC OUTPUT
 - ☒ PIN 1,2 : +V
 - ☒ PIN 3,4 : -V

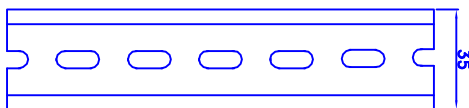
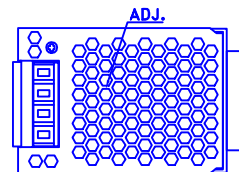
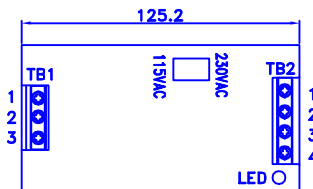
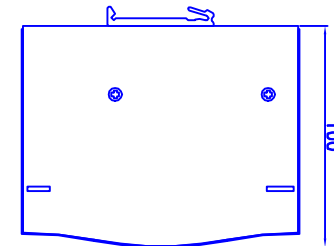
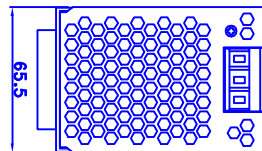

ADMISSIBLE DIN-RAIL: TS35/7.5 OR TS35/15

